

DMS3

Setup of parameters using buttons local control

Menu LCD

Appendix
74 1076 02

1. TABLE OF CONTENTS

1.	TABLE OF CONTENTS	2
2.	PARAMETERS SETUP	4
2.1.	LOCAL CONTROL WITH SETUP BUTTONS	7
2.2.	MENU LCD	7
2.3.	DESCRIPTION OF DISPLAYED DATA	8
2.3.1.	<i>Setup of parameters using buttons</i>	10
2.4.	DESCRIPTION OF DISPLAYED INFORMATION	11
2.5.	ENTERING MENU	11
2.5.1.	<i>Enter into settings without password</i>	11
2.5.2.	<i>Enter into password protected settings</i>	12
2.6.	LISTING AND SETTING PARAMETERS IN MENU, CHANGE AND RECORD PARAMETER	13
2.7.	MENU LCD – TEMPORARY INACCESSIBLE PARAMETER	14
2.8.	MENU LCD – INACCESSIBLE PARAMETER	14
2.9.	EXIT MENU	15
2.9.1.	<i>Exit MENU everywhere</i>	15
2.9.2.	<i>Exit MENU at the end of menu</i>	15
2.10.	MENU OVERVIEW	16
2.10.1.	<i>MENU 1 –Language</i>	16
2.10.2.	<i>MENU 2 –End position O</i>	17
2.10.3.	<i>MENU 3 – End position C</i>	18
2.10.4.	<i>MENU 4 – Calibration regulator</i>	19
2.10.5.	<i>MENU 5 – Shutting off at end limit</i>	20
2.10.6.	<i>MENU 6 – Operating torque O</i>	21
2.10.7.	<i>MENU 7 – operating torque C</i>	22
2.10.8.	<i>MENU 8 – Time of torque blocking</i>	23
2.10.9.	<i>MENU 9 – Position of torque blocking open</i>	24
2.10.10.	<i>MENU 10 –Position of torque blocking closed</i>	25
2.10.11.	<i>MENU 11 (for DMS 3 version) – Setup CPT</i>	26
2.10.12.	<i>MENU 11 (for MODBUS version) – Address</i>	27
2.10.13.	<i>MENU 11 (for Profibus version)– Address 1</i>	28
2.10.14.	<i>MENU 12 (for DMS 3 version) – Type of regulation</i>	29
2.10.15.	<i>MENU 12 (for Modbus version) – Baudrate</i>	30
2.10.16.	<i>MENU 12 (for Profibus version)– Address 2</i>	31
2.10.17.	<i>MENU 13 (for DMS 3 version) – Analog control signal</i>	32
2.10.18.	<i>MENU 13 (for Modbus version) – Parity</i>	33
2.10.19.	<i>MENU 13 (for Profibus version) – Redundancia</i>	34
2.10.20.	<i>MENU 14 (for DMS 3 version and Profibus version), resp. MENU 16 (for Modbus version) – Dead zone</i>	35
2.10.21.	<i>(for MODBUS version) – Redundancy</i>	36
2.10.22.	<i>MENU 15 (for DMS 3 version and Profibus version), resp. MENU 17 (for Modbus version) – Internal dead zone</i>	37
2.10.23.	<i>MENU 15 (for MODBUS version) – Connection check time</i>	38
2.10.24.	<i>MENU 16 (for DMS 3 version and Profibus version), resp. MENU 18 (for Modbus version) – Failure reaction</i>	39
2.10.25.	<i>MENU 17 (for DMS 3 version and Profibus version), resp. MENU 19 (for Modbus version) – Safe position ..</i>	40
2.10.26.	<i>MENU 18 (for DMS 3 version and Profibus version), resp. MENU 20 (for Modbus version) – Function of input I1</i>	41
2.10.27.	<i>MENU 19 (for DMS 3 version and Profibus version), resp. MENU 21 (for Modbus version) – Active level of input I1</i>	42
2.10.28.	<i>MENU 20 (for DMS 3 version and Profibus version), resp. MENU 22 (for Modbus version) – Function of input I2</i>	43
2.10.29.	<i>MENU 21(for DMS 3 version and Profibus version), resp. MENU 23 (for Modbus version) – Active level of input I2</i>	44
2.10.30.	<i>MENU 22 (for DMS 3 version and Profibus version), resp. MENU 24 (for Modbus version) – Thermal fuse by the reaction on failure</i>	45

2.10.31.	MENU 23(for DMS 3 version and Profibus version), resp. MENU 25 (for Modbus version) – Overheating deactivation	46
2.10.32.	MENU 24 (for DMS 3 version and Profibus version), resp. MENU 26 (for Modbus version) – Function of relay ready	47
2.10.33.	MENU 25, 27, 29, 31, 33 (for DMS 3 version and Profibus version), resp. MENU 27,29,31,33,35 (for Modbus version) – Function of relay 1 ... 5.....	48
2.10.34.	MENU 26, 28, 30, 32, 34 (for DMS 3 version and Profibus version), resp. MENU 28,30,32,34,36 (for Modbus version) – Position for Relay 1 ... 5.....	49
2.10.35.	MENU 35 (for DMS 3 version and Profibus version), resp. MENU 37 (for Modbus version) – Cycle mode	50
2.10.36.	MENU 36 (for DMS 3 version and Profibus version), resp. MENU 38 (for Modbus version) – Time of run of motor when cycle mode is enabled	51
2.10.37.	MENU 37 (for DMS 3 version and Profibus version), resp. MENU 39 (for Modbus version) – Time of pause of motor when cycle mode is enabled	52
2.10.38.	MENU 38 (for DMS 3 version and Profibus version), resp. MENU 40 (for Modbus version) – Tolerance O and C	53
2.10.39.	MENU 39 (for DMS 3 version and Profibus version), resp. MENU 41 (for Modbus version) – Information of system	54
2.10.40.	MENU 40 (for DMS 3 version and Profibus version), resp. MENU 42 (for Modbus version) – Restore parameters from backup.....	55
2.10.41.	MENU 41(for DMS 3 version and Profibus version), resp. MENU 43 (for Modbus version) – The creation of backup parameters.....	56
2.10.42.	MENU 42 (for DMS 3 version and Profibus version), resp. MENU 44 (for Modbus version) – Restoring factories setup.....	57
2.10.43.	MENU 43 (for DMS 3 version and Profibus version), resp. MENU 45 (for Modbus version) – Resetting active errors	58
2.10.44.	MENU 44 (for DMS 3 version and Profibus version), resp. MENU 46 (for Modbus version) – Actuator dir..	59
3.	REGISTER ERRORS AND WARNINGS.....	60

2. PARAMETERS SETUP

Menu			Name	Value of parameter	Description
DMS 3	MODBUS	PROFIBUS			
1			JAZ/LANGUAGE	CESKY ENGLISH	Language menu
2			POSITION O	SET	End position open
3			POSITION C	SET	End position closed
4			CALIBR.REG.	START	Start of calibration
5			END LIMIT	C = TOR, O = TOR C = TOR, O = POS C = POS, O = TOR C = POS, O = POS	End limit
6			TORQUE O	50..100 %	Working torque - open (option 50-69% depends on <i>torque min</i> parameter)
7			TORQUE C	50..100 %	Working torque - closed (option 50-69% depends on <i>torque min</i> parameter)
8			BLOCK. TIME	0..20 s	Time setup for torque blockage
9			BLOCK. POS. O	0.5 %	Setup the position for torque open blockage
10			BLOCK. POS. C	0.5 %	Setup the position for torque closed blockage
11	-	-	CPT	4-20 mA 20-4 mA	Type of CPT
12	-	-	REGULATION	2P 3P 3P/2P I2	Type of regulation
13	-	-	ANALOG. INPUT	4-20 mA (2-10 V) 20-4 mA (10-2 V) 0-20 mA (0-10 V) 20-0 mA (10-0 V) 4-12 mA 12-20 mA 20-12 mA 12-4 mA	Type of analog control signal
14	16	14	DEAD ZONE	1..10 %	Dead zone
15	17	15	INT. DEAD. Z.	0,5..3,0 %	Internal dead zone
16	18	16	FAIL.REACT.	POS.OPEN POS.CLOSE STOP SAFE POSIT.	Reaction on SAFE and loss control signal
17	19	17	SAFE POSIT.	0..100 %	Safe Position
18	20	18	FUNCTION I1	DISABLED ESD RELEASE LOC. STOP	Function of input I1
19	21	19	ACTIVE I1	LOW LEVEL HIGH LEVEL	Active level of input I1
20	22	20	FUNCTION I2	DISABLED ESD RELEASE LOC. 2P (E2P)	Function of input I2
21	23	21	ACTIVE I2	LOW LEVEL HIGH LEVEL	Active level of input I2

Menu			Name	Value of parameter	Description
DMS 3	MODBUS	PROFIBUS			
22	24	22	THERMO.FAIL.	FUSE ACTIVE FUSE IGNORED	Reaction of SAFE when overheating is activated
23	25	23	THERMO.RESET	AUTOMATICAL. LOCAL CONTR.	Overheating deactivation
24	26	24	READY RELAY	ERROR WARN. / ERROR ERR / N.REMOTE WAR / ERR / NREM	Function of relay ready
25	27	25	RELAY 1	DISABLED POSITION O POSITION C TORQUE O TORQUE C TORQUE O/C TORQ.O / POS.O TORQ.C / POS.C OPEN CLOS MOVE MOVE - TWINKLE TO POSITION FROM POSITION WARNING LOCAL CONT. REMOTE CONT. OFF RELAY READY	Function of relay 1
26	28	26	RELAY 1 POS.	0..100%	Position for RELAY 1
27	29	27	RELAY 2	according to RELAY1	Function of relay 2
28	30	28	RELAY 2 POS.	0..100%	Position for RELAY 2
29	31	29	RELAY 3	according to RELAY1	Function of relay 3
30	32	30	RELAY 3 POS.	0..100%	Position for RELAY 3
31	33	31	RELAY 4	according to RELAY1	Function of relay 4
32	34	32	RELAY 4 POS.	0..100%	Position for RELAY 4
33	35	33	RELAY 5	according to RELAY1	Function of relay 5
34	36	34	RELAY 5 POS.	0..100%	Position for RELAY 5
35	37	35	CYCLE MODE	DISABLED DIRECT. O DIRECT. C DIRECT. O+C	Mode cycle regime
36	38	36	CYCLE RUN. T.	1..250 s	Time of run of motor when cycle mode is enabled
37	39	37	CYCLE PAUSE	1..250 s	Time of pause of motor when cycle mode is
38	40	38	OC TOLERANCE	0,0..5,0 %	Tolerance O and C
39	41	39	INFORMATION	FW ECU FW POS. FW TORQ. FW LED FW LCD FW P/RE L.ERROR 1 L.ERROR 2 L.ERROR 3 TORQUE TEMPER.	Information of system
40	42	40	RESTORE BACK	START	Restore from saved parameters
41	43	41	CREATE BACK.	START	Create saved parameters
42	44	42	RESTORE FACT	START	Restore factories setup
43	45	43	ACTIVE ERR.	CLEAR	Clear active errors

Menu			Name	Value of parameter	Description
DMS3	MODBUS	PROFIBUS			
44	46	44	ACTUATOR DIR	RIRHT SPIN	Actuator direction
				LEFT SPIN	
-	11	-	ADDRESS	1...247	Electric actuator address on Modbus interface
-	12	-	Baudrate	300 bit/s	Modbus – Baudrate
				600 bit/s	
				1200 bit/s	
				2400 bit/s	
				4800 bit/s	
				9600 bit/s	
				19200 bit/s	
				38400 bit/s	
				57600 bit/s	
				115200 bit/s	
-	13	-	PARITY	EVEN	Modbus - Parity
				ODD	
				NO	
-	14	-	REDUNDANCY	OFF	Modbus - Redundancy
				CABEL	
				COMPONENT	
				REPEATER	
-	15	-	CONNECTION CHECK TIME	0,1...25,5 s	Modbus – connection check time
-	-	11	ADDRESS 1	1...126	Profibus - Channel 1 address
-	-	12	ADDRESS 2	1...126	Profibus - Channel 2 address
-	-	13	REDUNDANCE	OFF	Profibus - Redundand
				SIMPLE	

2.1. Local control with setup buttons

1. PADLOCK
2. BUTTON REMOTE - OFF - LOCAL
3. BUTTON OPEN /
4. BUTTON CLOSE /
5. BUTTON STOP / ESC
6. LCD DISPLAY
7. LED INDICATING RUN AND ERROR

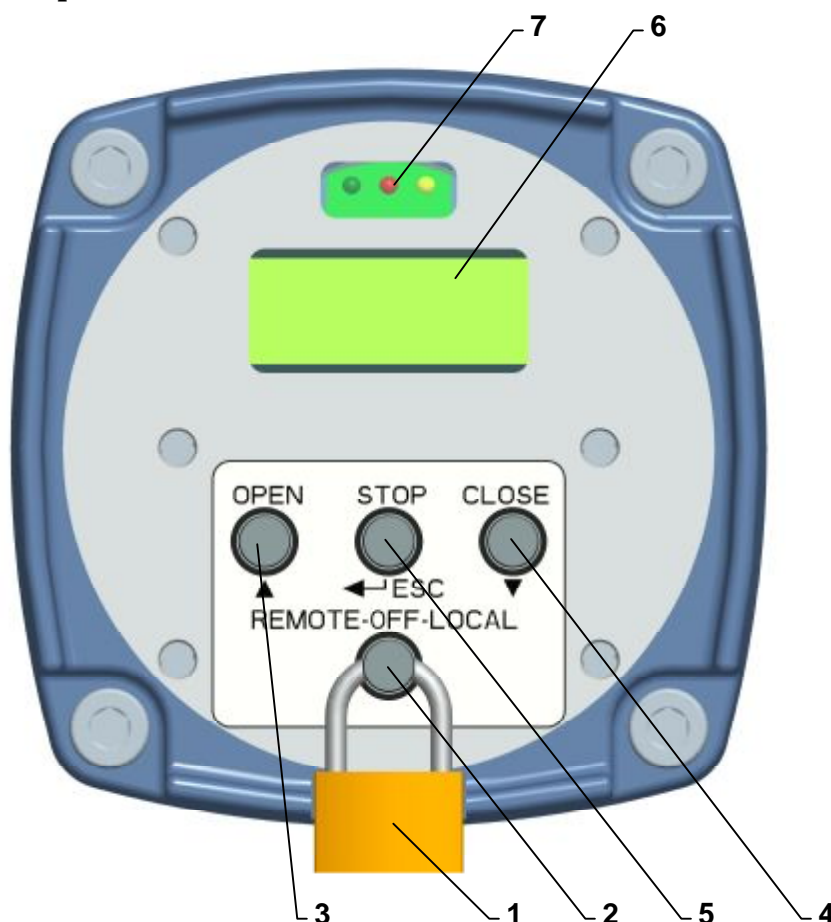

2.2. MENU LCD



- Enter into MENU is possible only by the position switch block local control=OFF.
- MENU will disable control duty actuator.
- While no are they 4 minutes pressed none button and is not communication serial line, is MENU automatically close and system myself return in regulation duty.



- Enter in MENU can be limited password (parameter *Password*), see. chapter MENU LCD - enter in menu protected password.
- MENU is modified actual configuration the system, parameters oneself bet temporary inaccessible, see. Chapter MENU LCD – temporary inaccessible parameter.
- Record parameters can be limited enter authorized (parameter *Enter*), short-circuit admittance parameters oneself bet inaccessible, see. Chapter MENU LCD – inaccessible parameter
- In the MENU is possible to use for faster changes values parameters or numbers MENU function Autorepeat, i.e. hold button ▼▲ come to automatically increase or reduction values.
- **Note:** In the ES version with local control, with I1 function set to the value "LOCAL CONTROL BLOCK RELEASE" using the EHL explorer program, or by push buttons on the local control (MENU 18 on local control), after leaving the MENU, control buttons of the control unit and the local control are blocked. This condition is signaled on LCD display of the local control with the sign *VYP. (OFF) or *DALK. (REMOTE), or *MIESTNE (LOCAL). Push buttons are accessible again by activation of input I1, or by changing the setting of I1 function to a value different than "LOCAL CONTROL BLOCK RELEASE" using the EHL explorer program.



Local controls LCD display does not screen with the ambient temperature lower then -25°C.

2.3. Description of displayed data

Mode		Displayed message
After power on		<div style="border: 1px solid black; padding: 10px; width: fit-content; margin: 0 auto;">R E S E T</div>
Operation mode	Example	<div style="border: 1px solid black; padding: 10px; width: fit-content; margin: 0 auto;"> 0 % S T O P R E M O T E </div>
	Position	<div style="border: 1px solid black; padding: 10px; width: fit-content; margin: 0 auto;">0 %</div> <div style="text-align: center; margin: 10px 0;">⇓</div> <div style="border: 1px solid black; padding: 10px; width: fit-content; margin: 0 auto;">1 0 0 %</div>
	Torque closed	<div style="border: 1px solid black; padding: 10px; width: fit-content; margin: 0 auto;">T O R Q . C</div>
	Torque open	<div style="border: 1px solid black; padding: 10px; width: fit-content; margin: 0 auto;">T O R Q . O</div>
	Control is turned off	<div style="border: 1px solid black; padding: 10px; width: fit-content; margin: 0 auto;">O F F</div>
	Local control	<div style="border: 1px solid black; padding: 10px; width: fit-content; margin: 0 auto;">L O C A L</div>
	Remote control	<div style="border: 1px solid black; padding: 10px; width: fit-content; margin: 0 auto;">R E M O T E</div>
Error or more errors	Blinking	

<p>Error or several errors occurred (also for warnings).</p>	<p>Operating message and error messages are cyclically displayed.</p>	<pre> 0 % S T O P R E M O T E ↓ E R R O R 4 T O R Q U E ↓ 0 % S T O P R E M O T E ↓ E R R O R 1 2 S E N S O R T O R Q . ↓ 0 % S T O P R E M O T E </pre>
<p>Setup parameter there's no point in relative to actual select system function</p>		<pre> I M P O S S I B L E </pre>
<p>Edit given parameter is forbidden (change from PC with required qualified)</p>		<pre> N O A C C E S S </pre>
<p>Setup from PC app.</p>		<pre> > > S E T U P < < < </pre>
<p>Reset of sensor.</p>		<pre> R E S E T </pre>

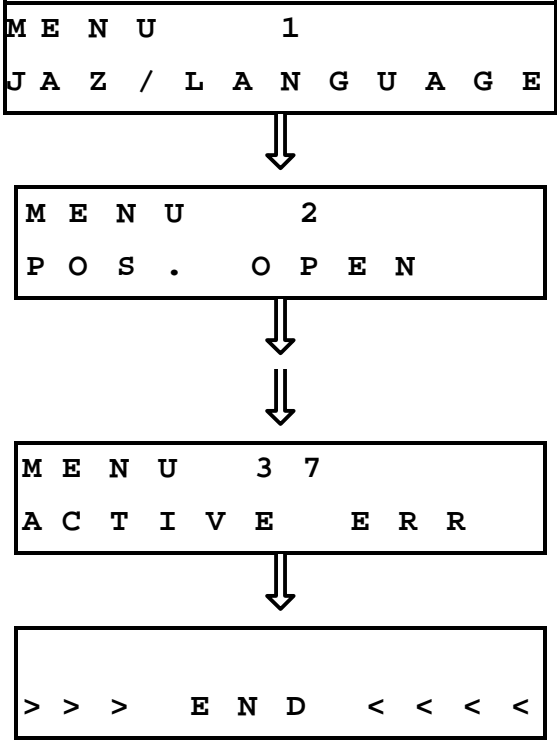
2.3.1. Setup of parameters using buttons

Mode		Displayed message
Selection of menu.		 <pre> MENU 1 J A Z / L A N G U A G E ↓ MENU 2 P O S . O P E N ↓ MENU 3 7 A C T I V E E R R ↓ > > > E N D < < < < </pre>
Setup of parameter.		 <pre> C E S K Y J A Z / L A N G U A G E </pre>
Record of parameter.		 <pre> C E S K Y > W R I T I N G < < </pre>



- Entering the menu is enabled only when remote and local control are disabled. Display shows OFF (REMOTE – OFF – LOCAL).
- Entering the menu disabled common operating mode.
- After 4 minutes of inactivity is menu mode automatically switched to common operating mode.

2.4. Description of displayed information

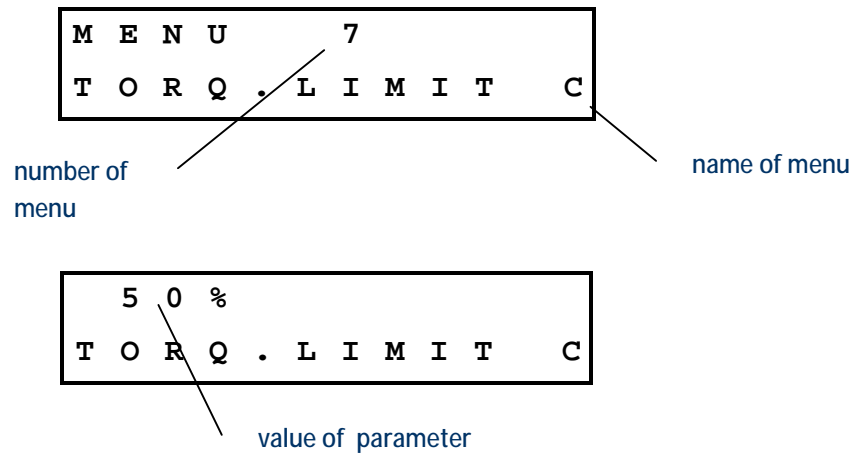

2.5. Entering menu

2.5.1. Enter into settings without password

Set switch remote - off - local
to position OFF.

Press and hold button.

← ESC



```

M E N U      1
J A Z / L A N G U A G E
  
```

Release the button.

← ESC

2.5.2. Enter into password protected settings

Change switch
REMOTTE.-OFF-LOCAL
into position
OFF

Press and hold button.

← ESC



0	0	0	0	0			
P	A	S	S	W	O	R	D

Press the button,



for insert value
password



3	0	0	0	0			
P	A	S	S	W	O	R	D

Press the
button,

← ESC



3	0	0	0	0			
P	A	S	S	W	O	R	D

pass by next code
password

Step by step supply all
cods of password



3	8	1	1	7			
P	A	S	S	W	O	R	D

Confirm entry by
pressing and hold
button

← ESC

Entry flowing

M	E	N	U	1							
J	A	Z	/	L	A	N	G	U	A	G	E

Entry disallowed

F	A	L	S	E	P	A	S	S	W	.
---	---	---	---	---	---	---	---	---	---	---

Number tests is limited on 5. Next must be actuator out - of - operation and open for option of again enter password.

Release button

← ESC

2.6. Listing and setting parameters in menu, change and record parameter

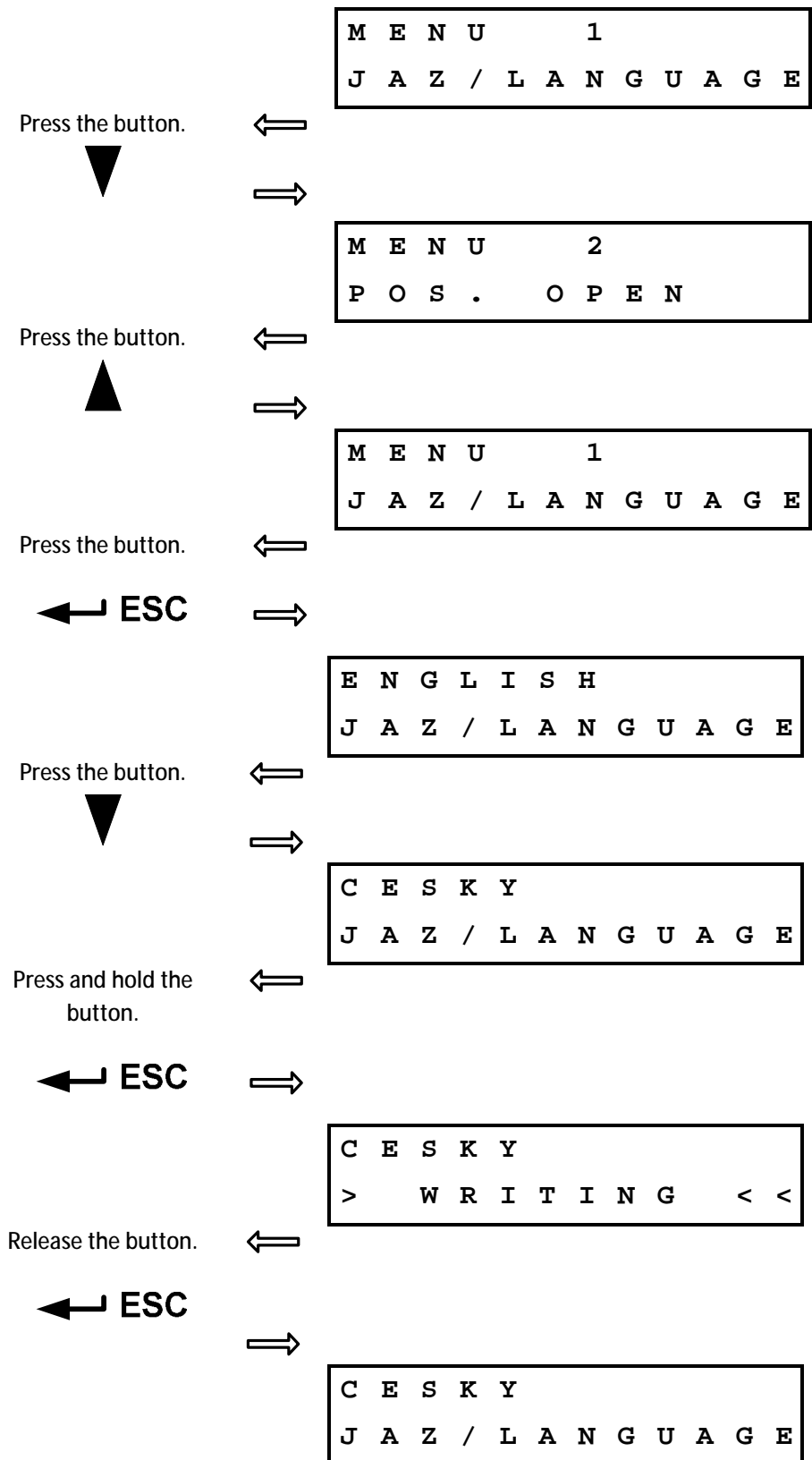

2.7. MENU LCD – temporary inaccessible parameter

- Unless be on display displayed following writing, parameter it's no use for actual configuration the system, is temporary inaccessible.

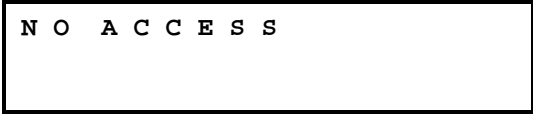

N O A C C E S S

2.8. MENU LCD – inaccessible parameter

- Unless are they by the record parameters on display displayed following writing, just so parameter inaccessible to record



I M P O S S I B L E
> > W R I T I N G < < <

- Accessing parameter is possible to change parameter access by program EHL Explorer with corresponding legitimate (HW key).

2.9. Exit MENU

2.9.1. Exit MENU everywhere

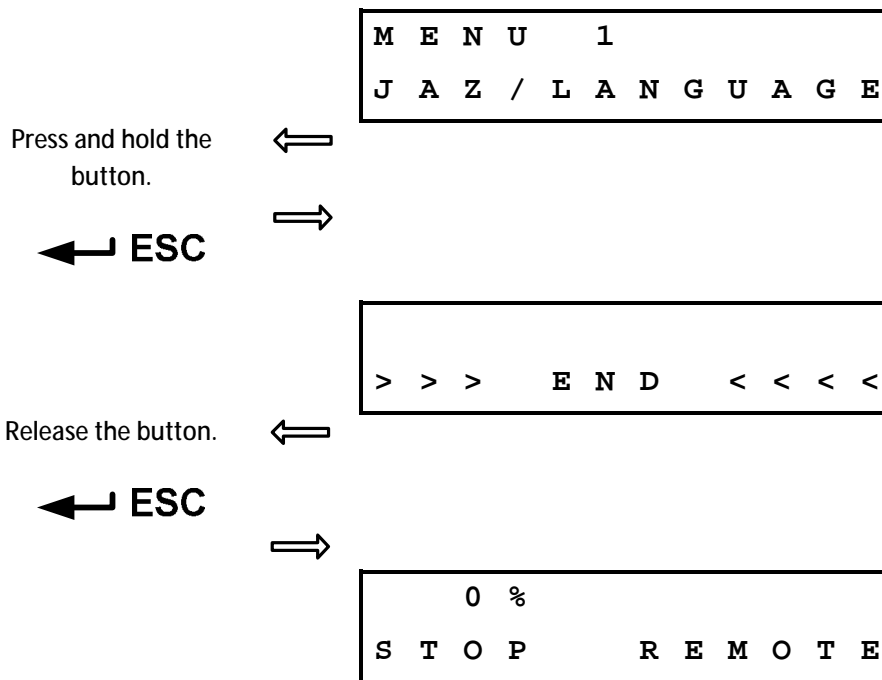

2.9.2. Exit MENU at the end of menu

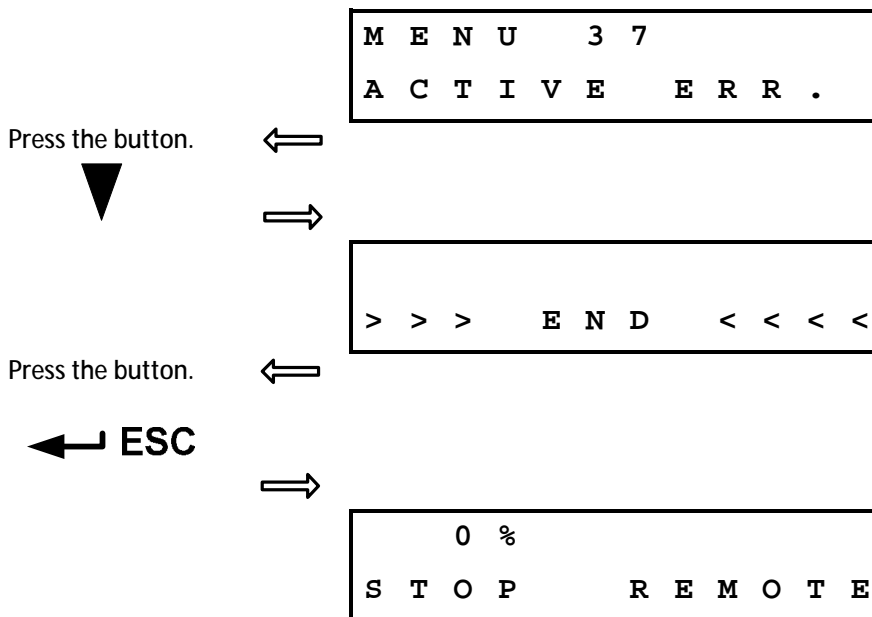

2.10. MENU overview

2.10.1.MENU 1 –Language

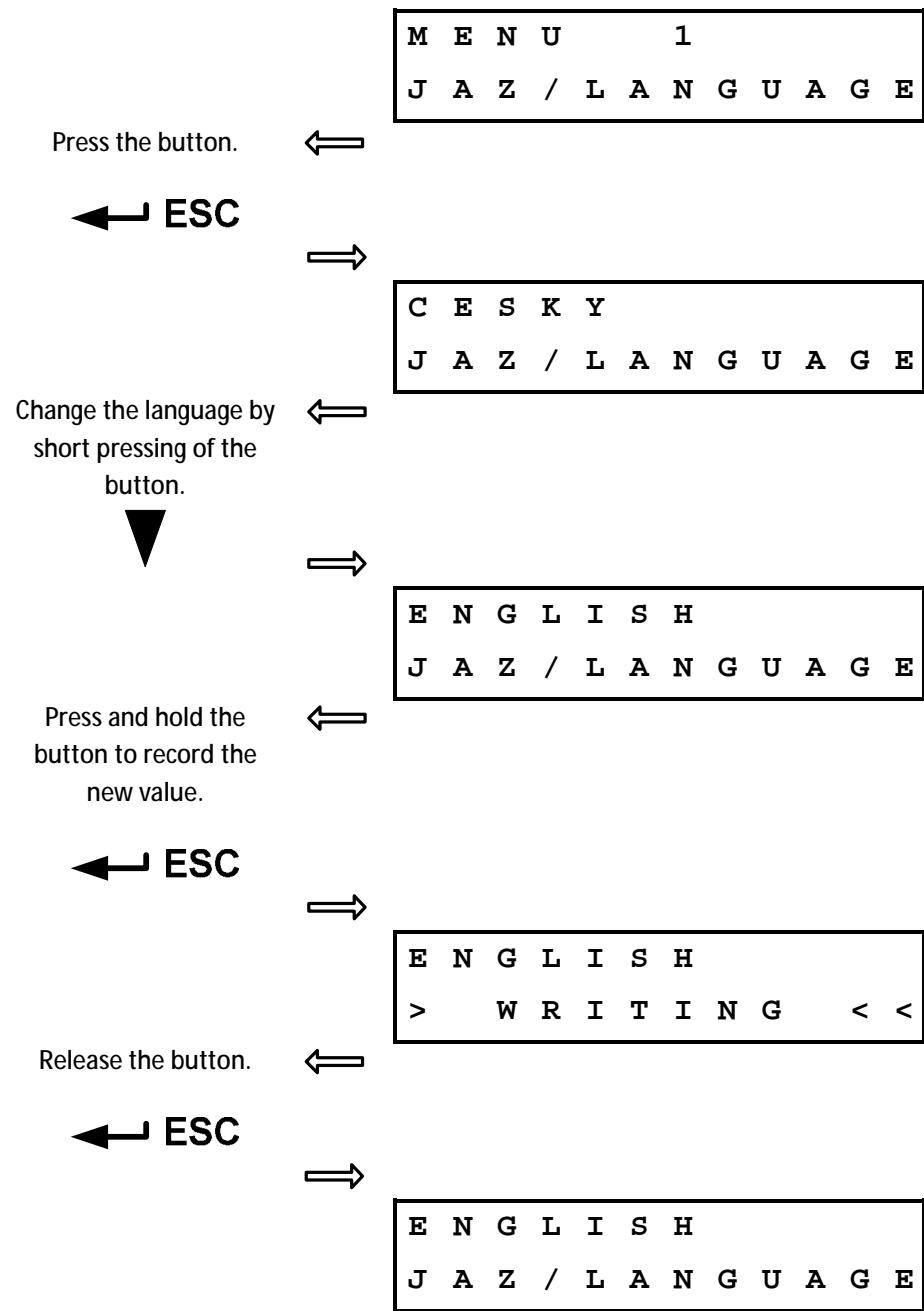

2.10.2.MENU 2 –End position 0

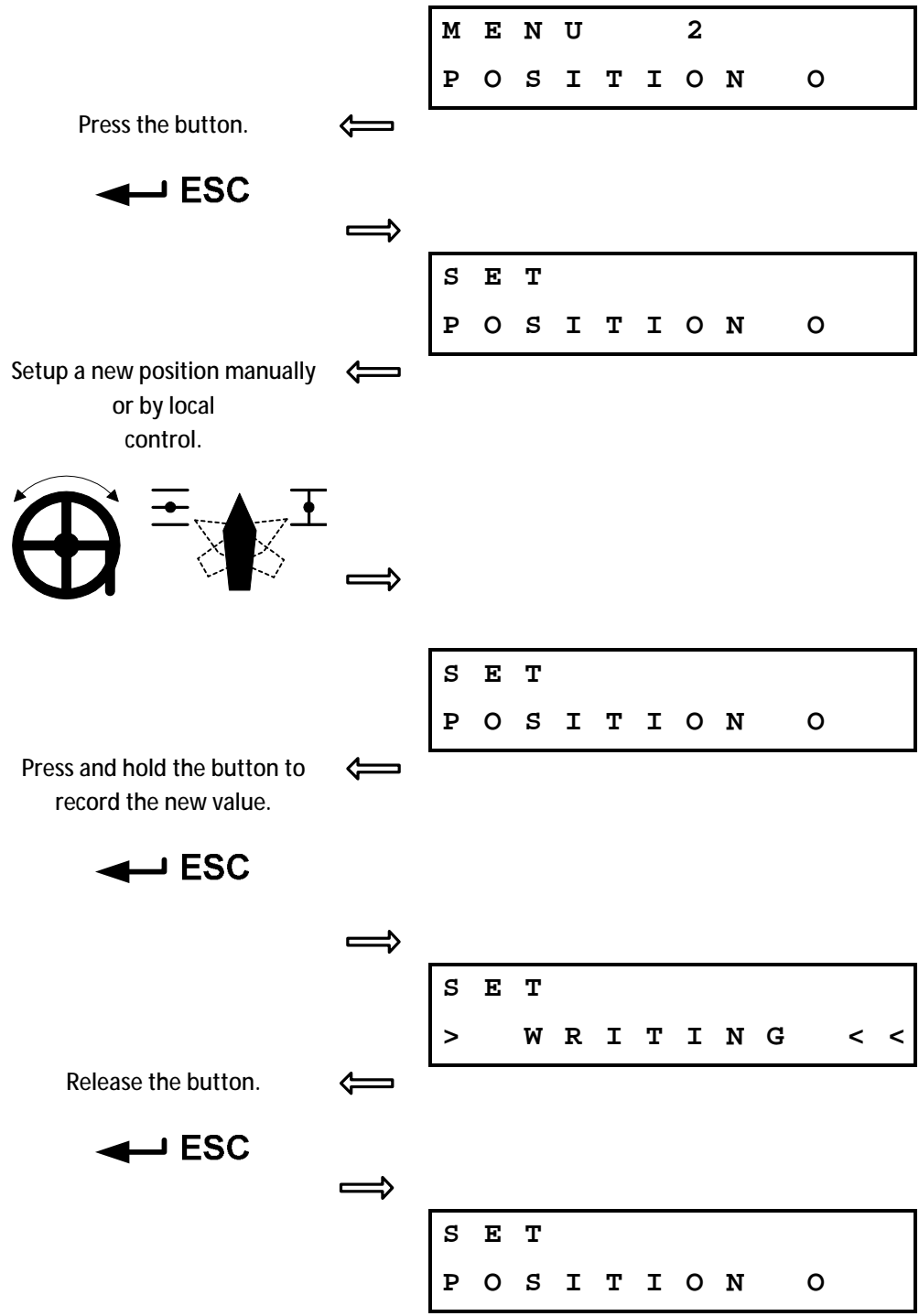

2.10.3. MENU 3 – End position C

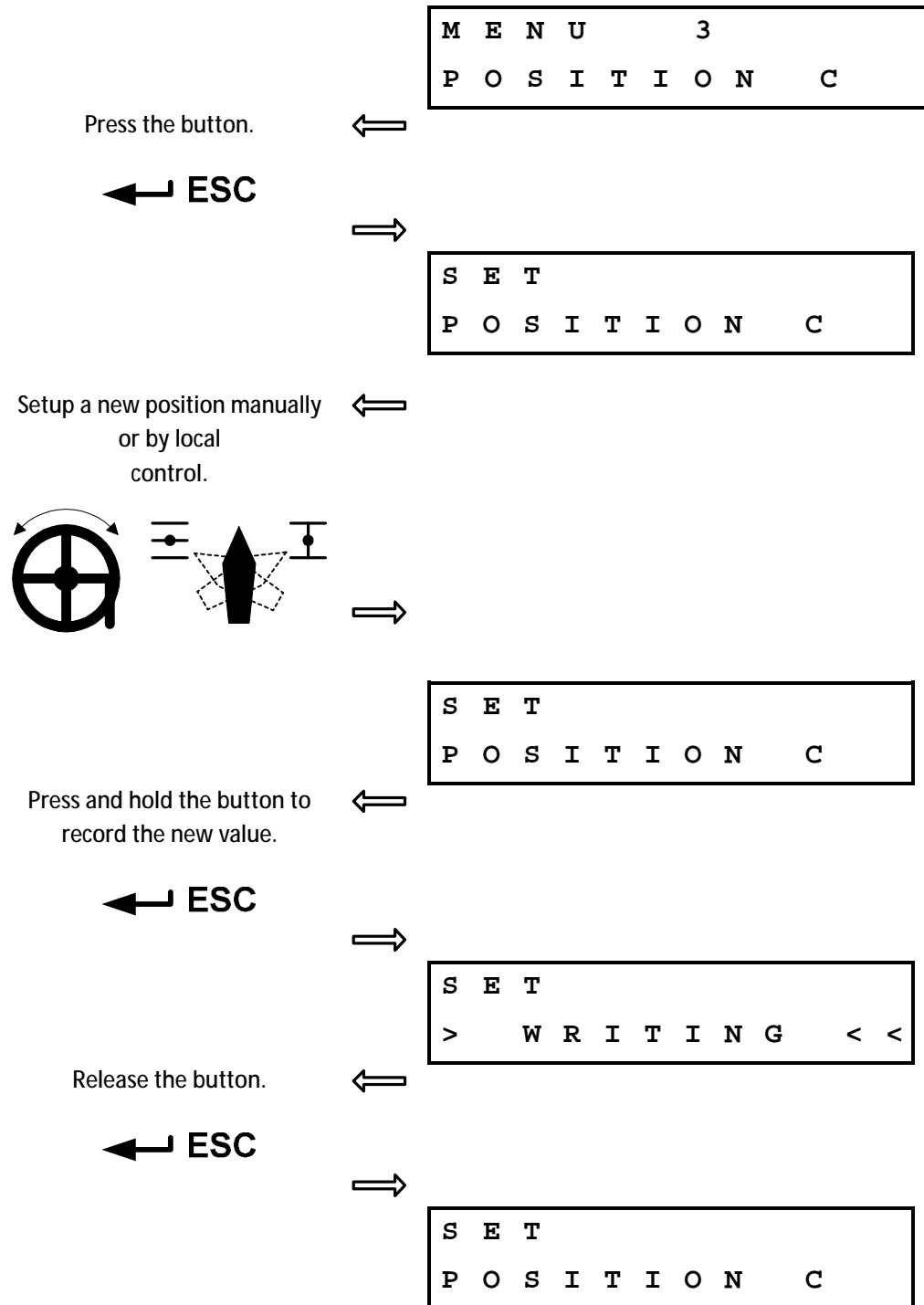

2.10.4.MENU 4 – Calibration regulator



§ During calibration regulator arrive to near turning actuator at two directions.
 § Be needed provide conditions for free turning actuator.

Press the button. ←

M E N U	4
K A L I B R . R E G	

← ESC

→

S T A R T	
K A L I B R . R E G	

Press and hold the button to run calibration. ←

← ESC

→

R U N	
> W R I T I N G < <	

Release the button. ←

← ESC

WAIT!
The actuator is moving!



→

O K	
K A L I B R . R E G	

OK – successfully finished

→

E R R O R	3
K A L I B R . R E G	

Error 3 – during calibration occurred error number 3 (see tab. Register errors...)

2.10.5.MENU 5 – Shutting off at end limit

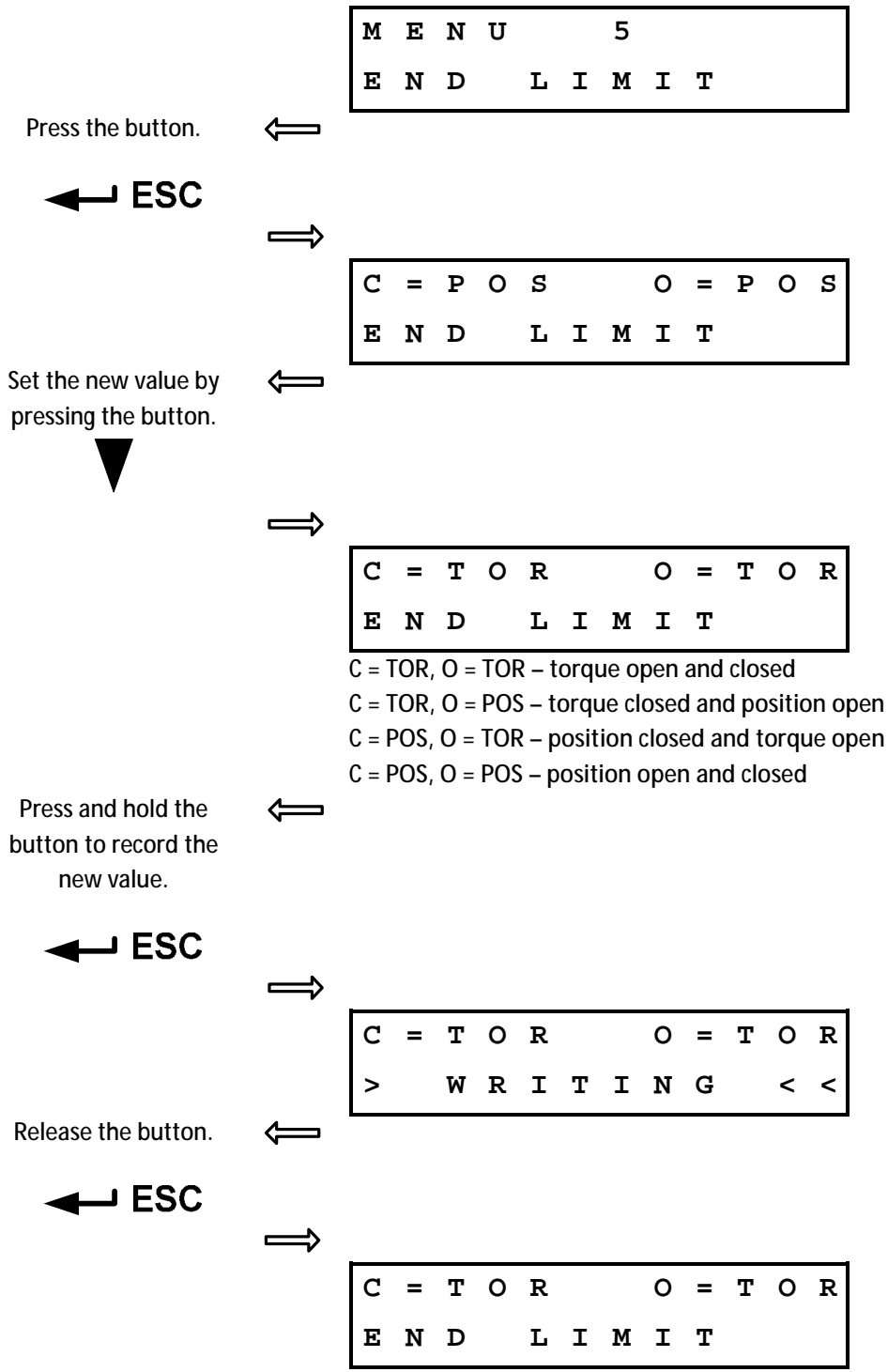

2.10.6.MENU 6 – Operating torque 0

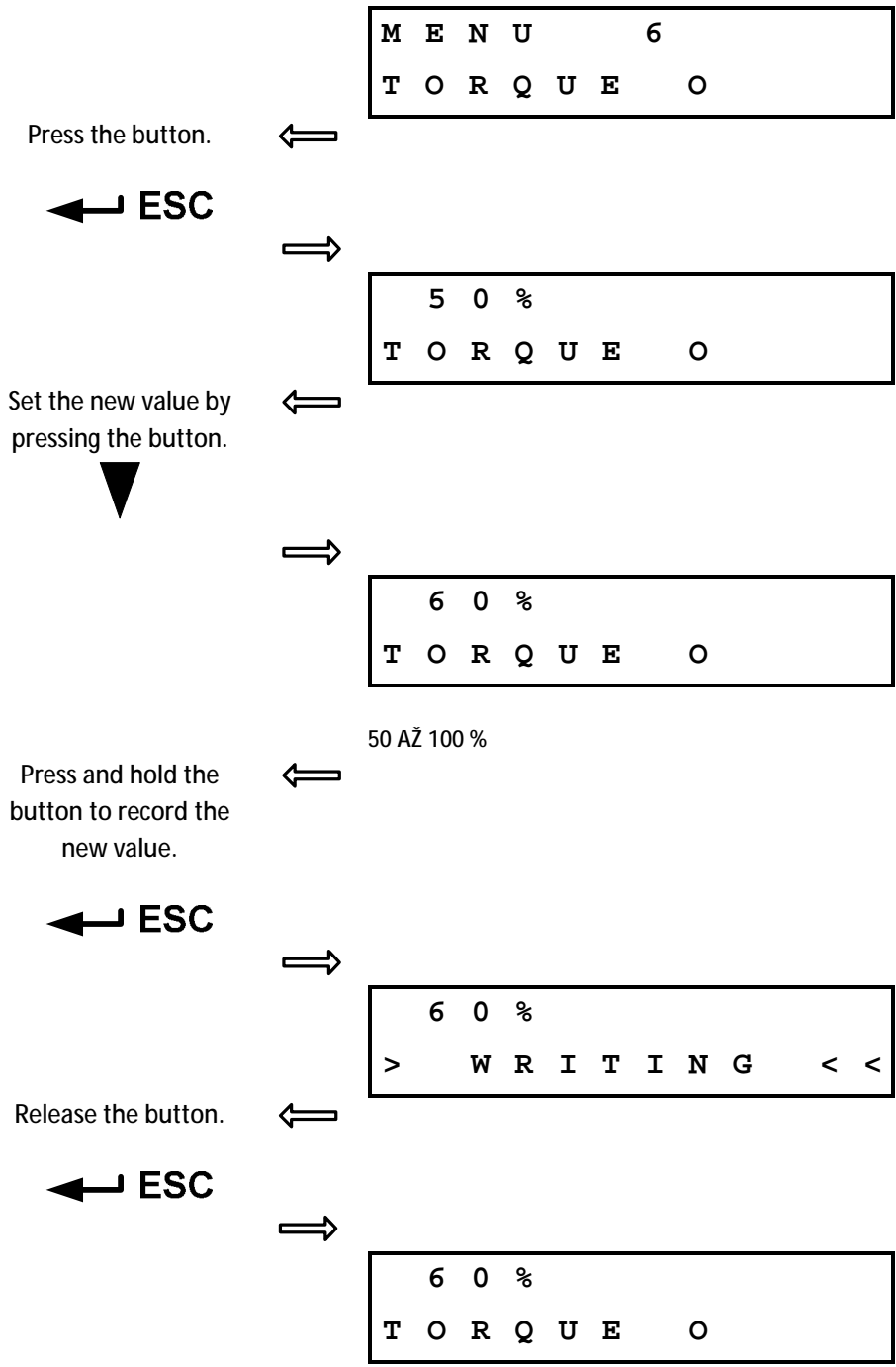

2.10.7.MENU 7 – operating torque C

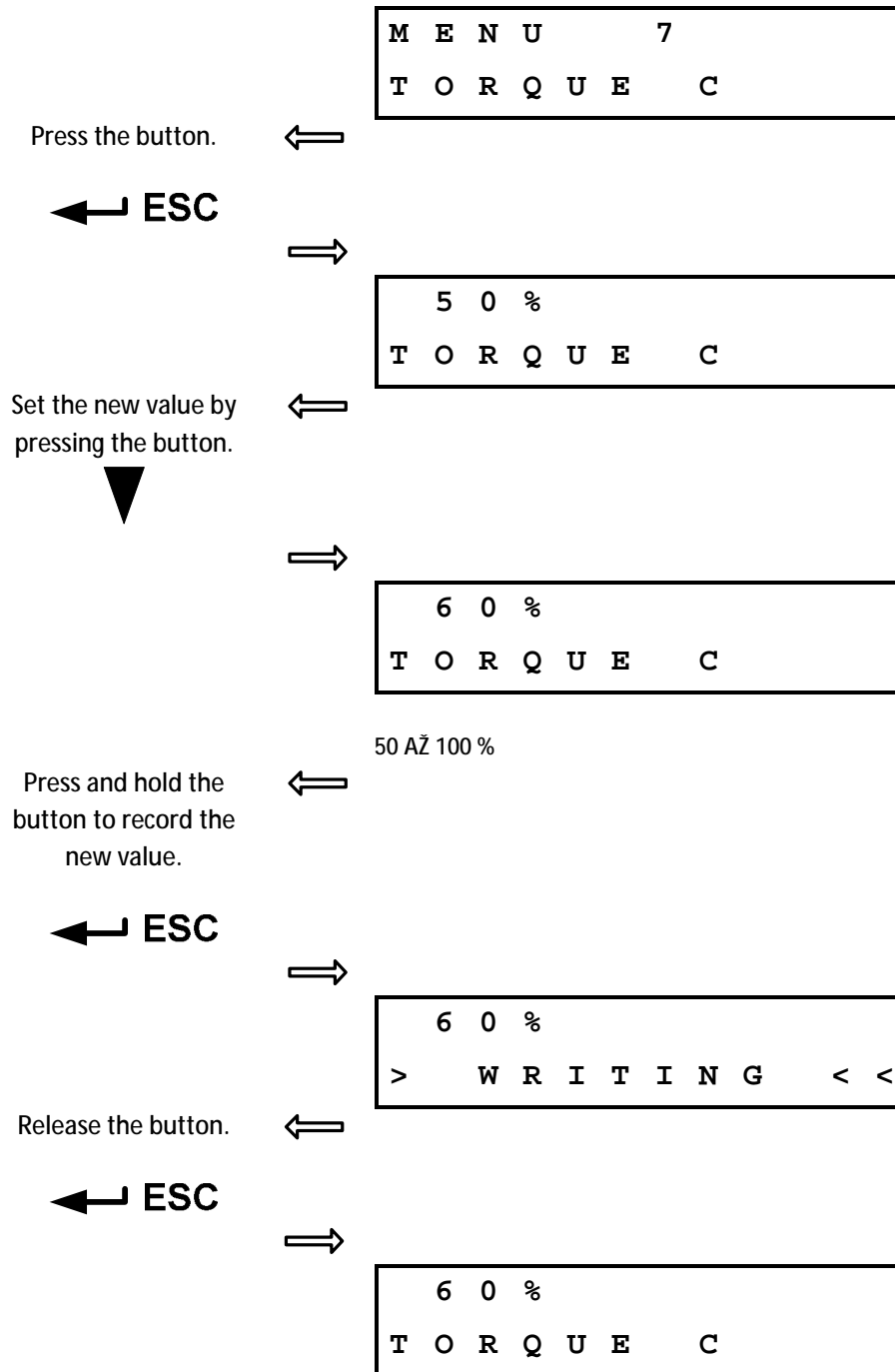

2.10.8.MENU 8 – Time of torque blocking

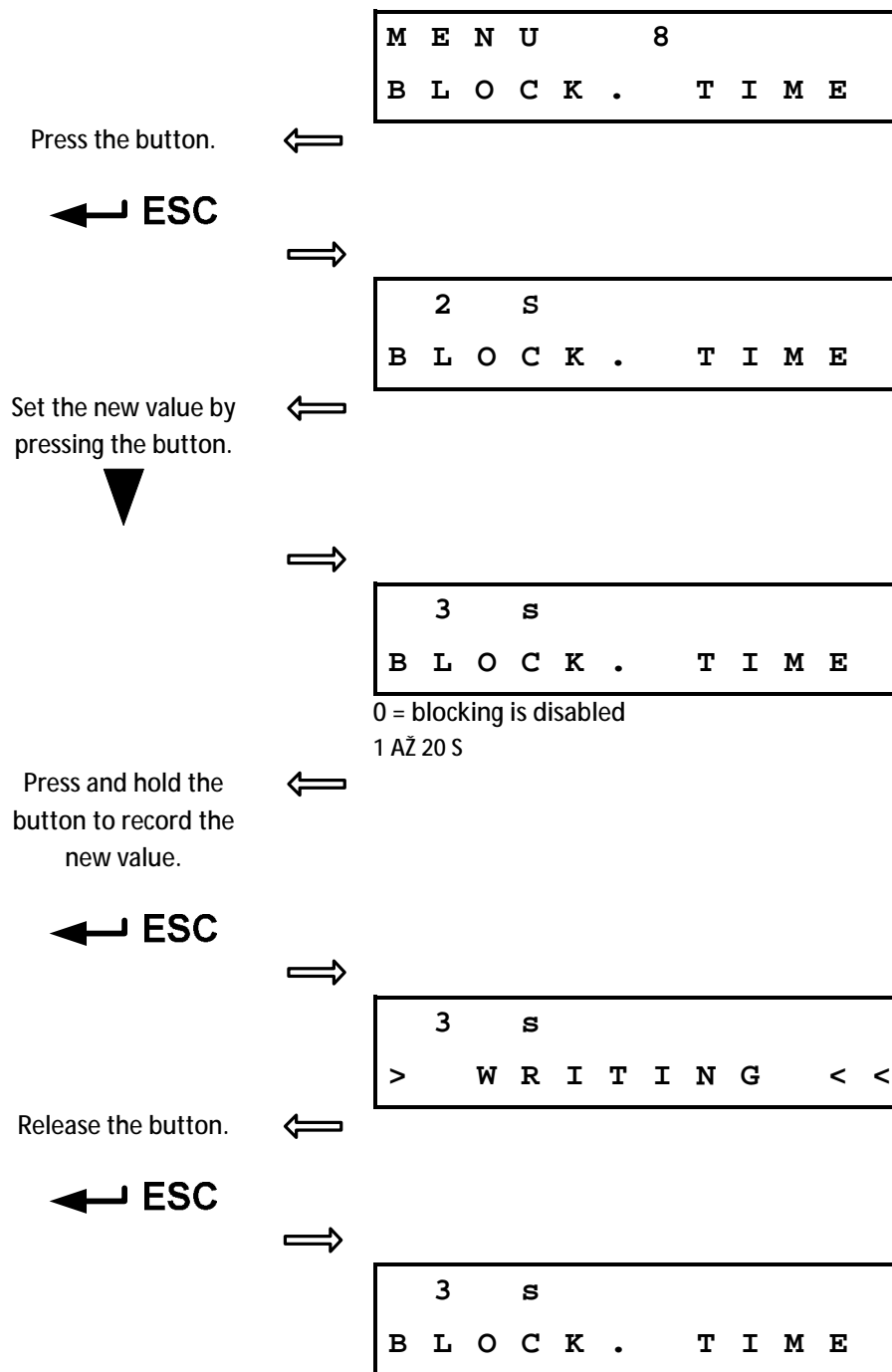

2.10.9.MENU 9 – Position of torque blocking open

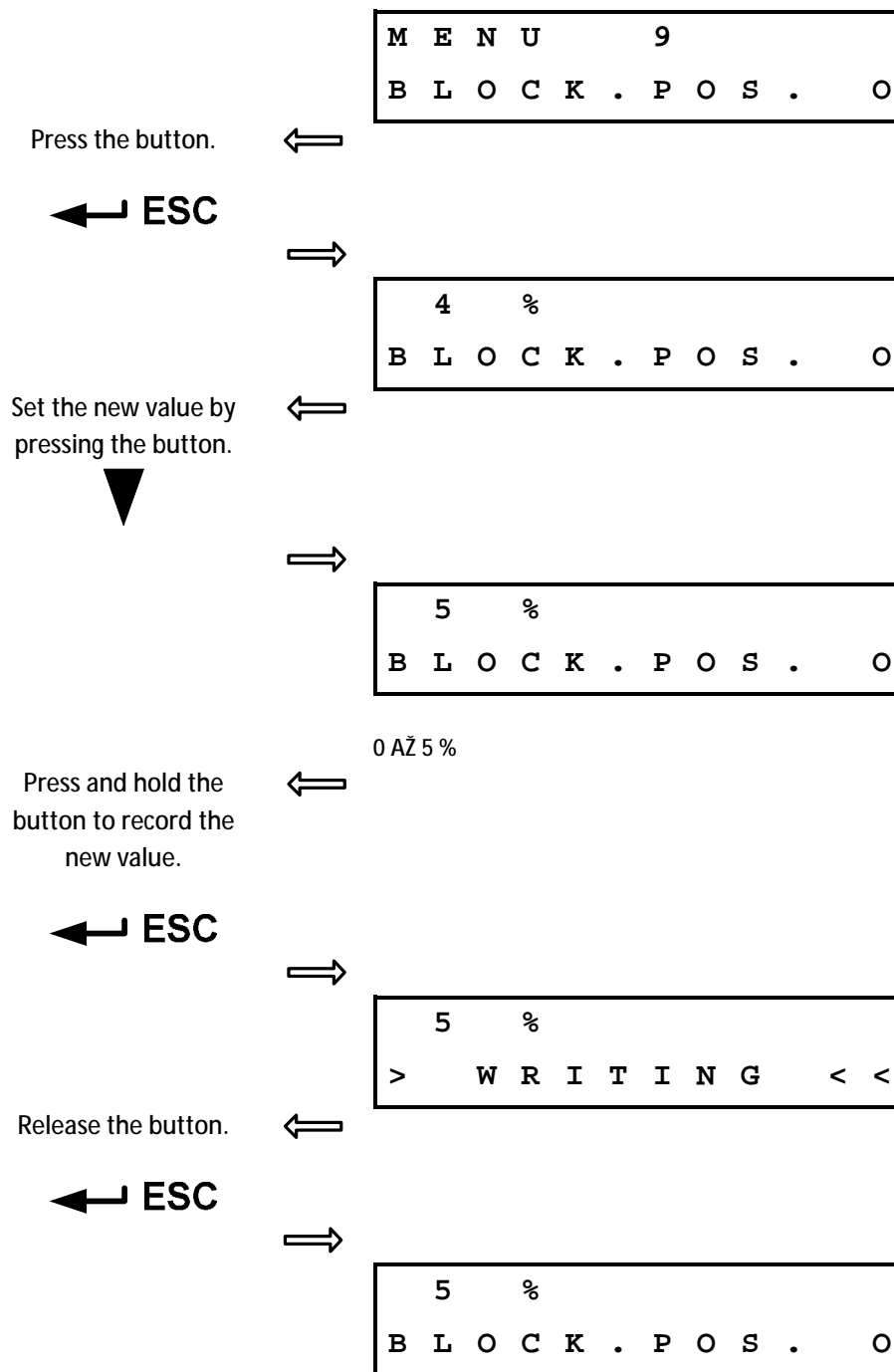

2.10.10. MENU 10 –Position of torque blocking closed

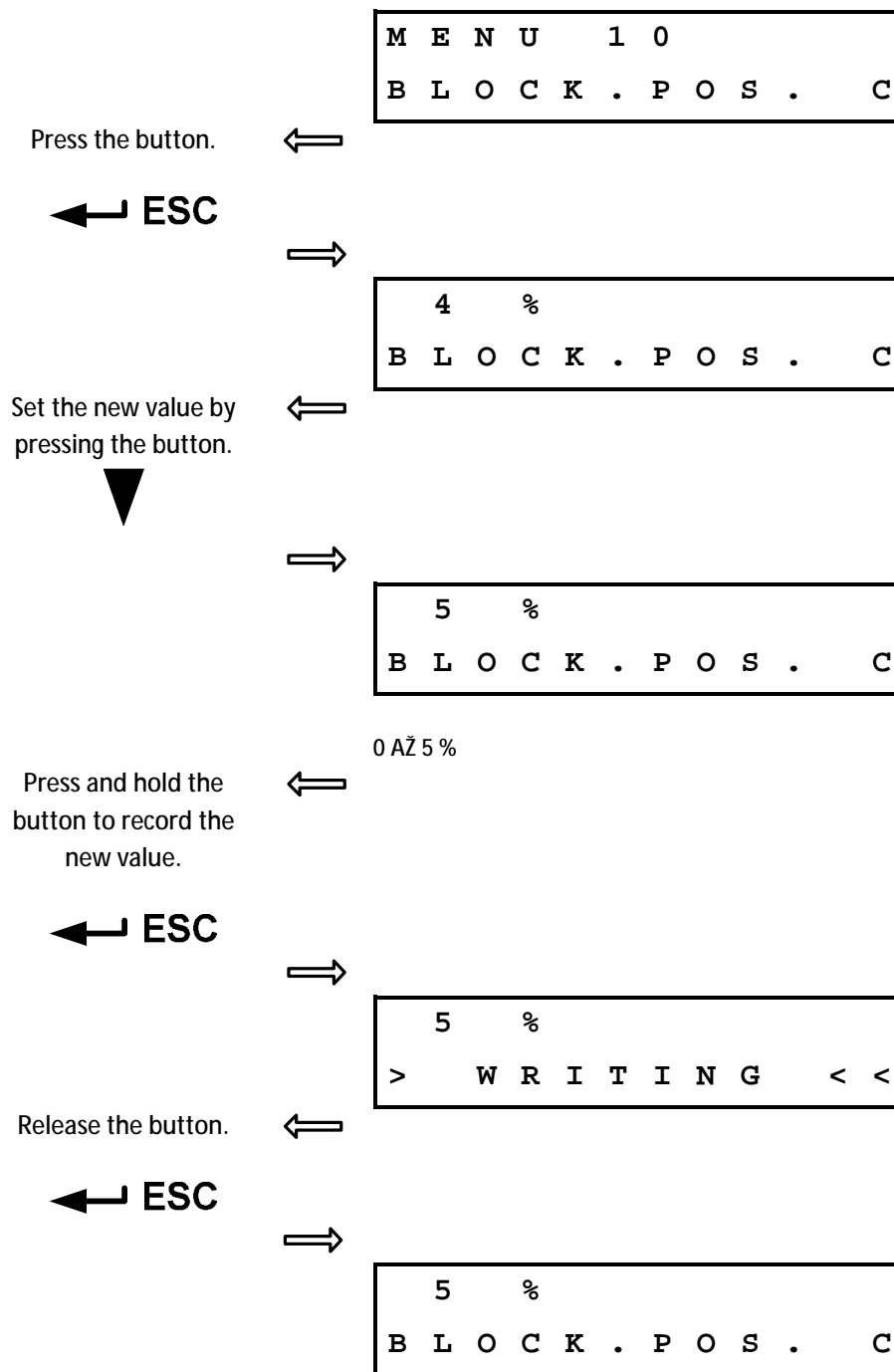

2.10.11. MENU 11 (for DMS 3 version) – Setup CPT

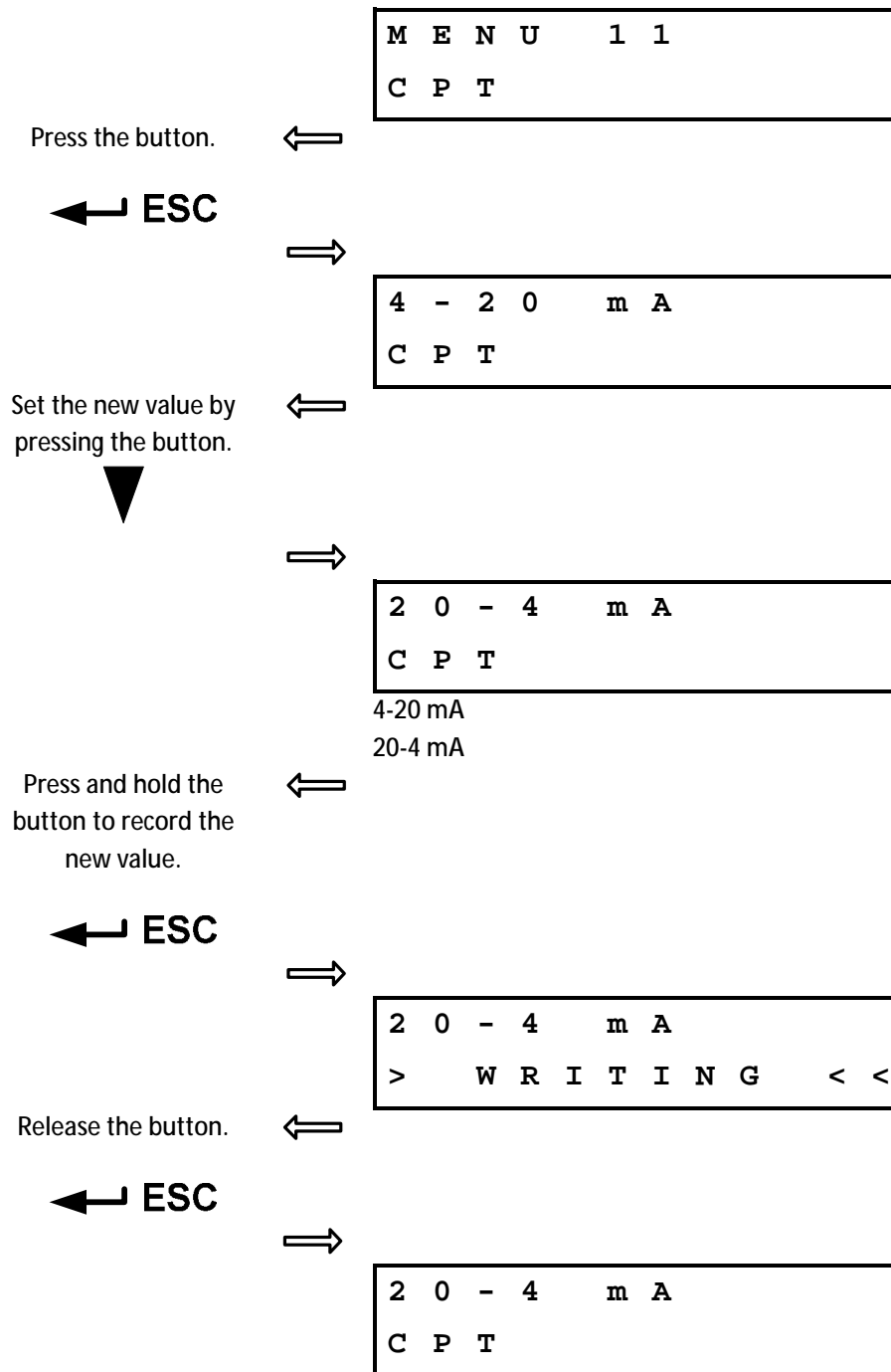

2.10.12. MENU 11 (for MODBUS version) – Address

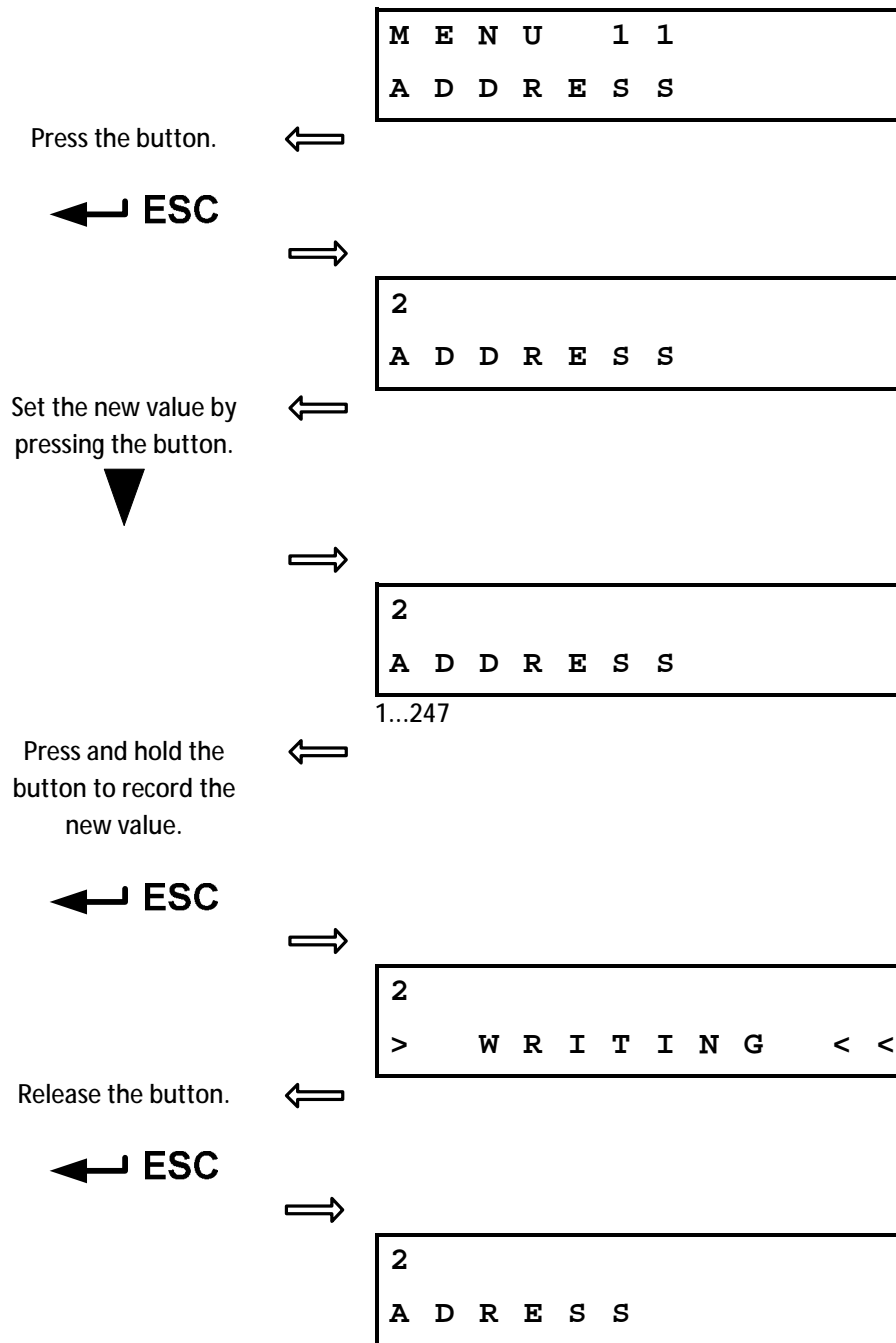

2.10.13. MENU 11 (for Profibus version)– Address 1

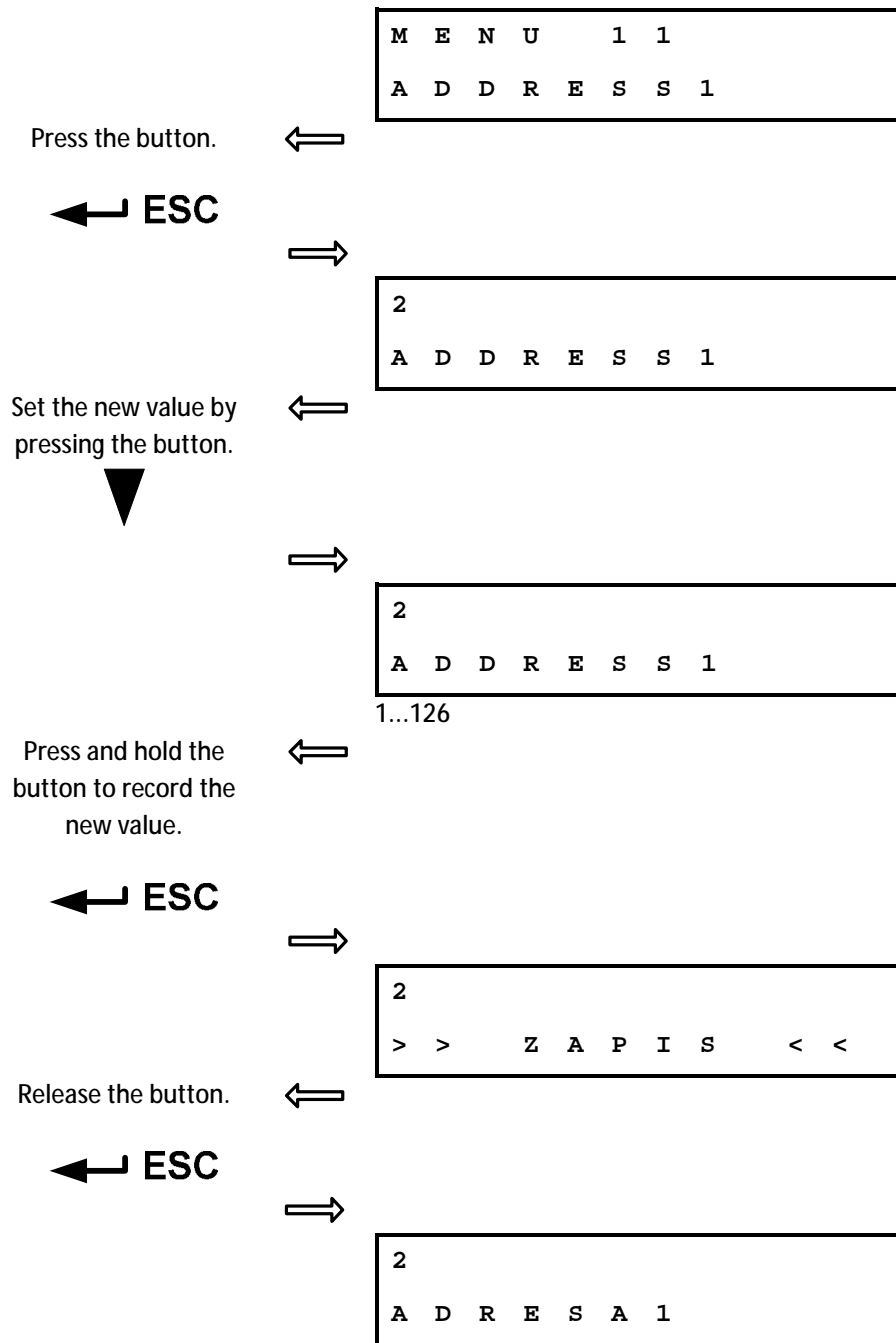

2.10.14. MENU 12 (for DMS 3 version) – Type of regulation

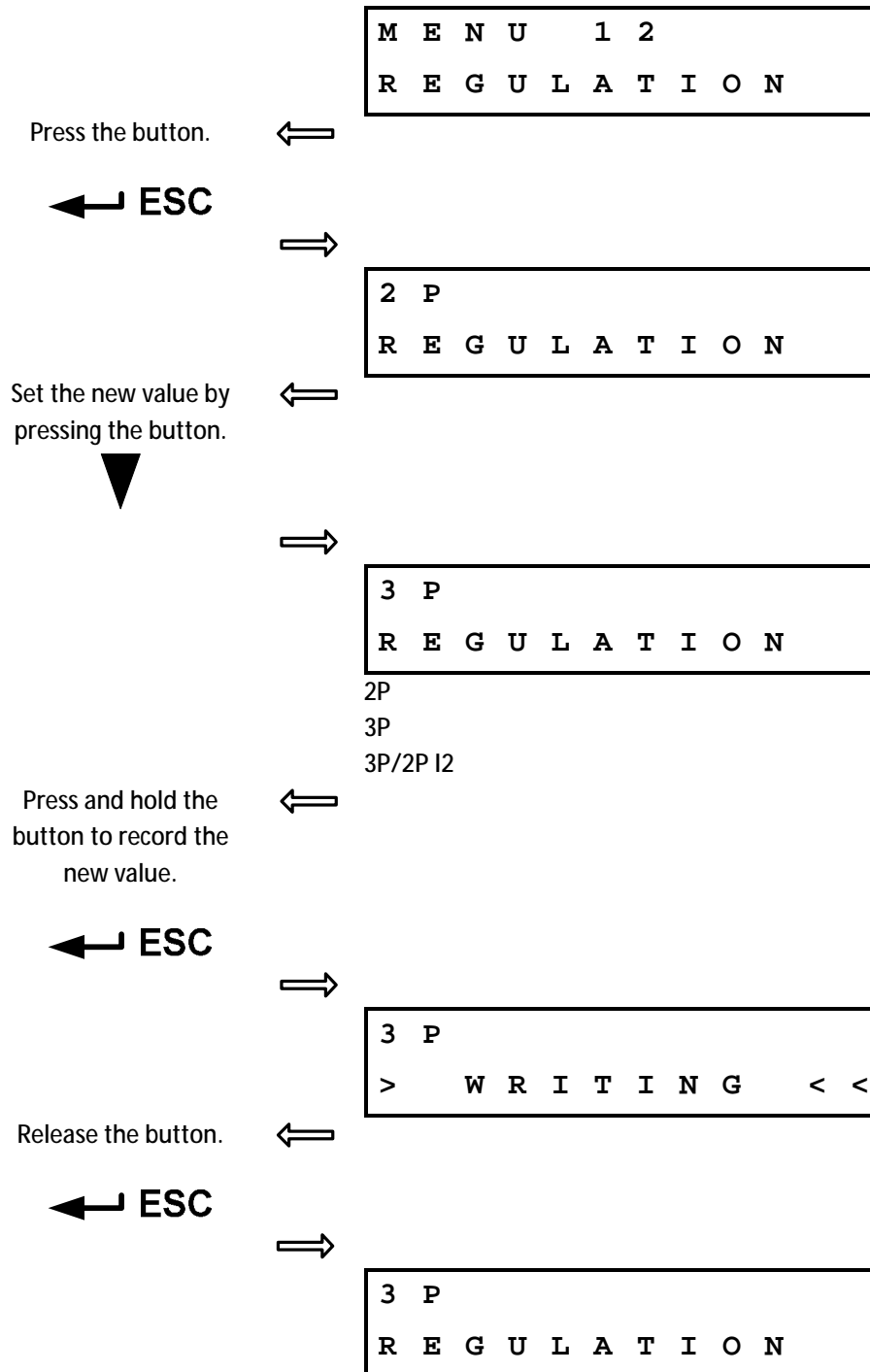

2.10.15. MENU 12 (for Modbus version) – Baudrate

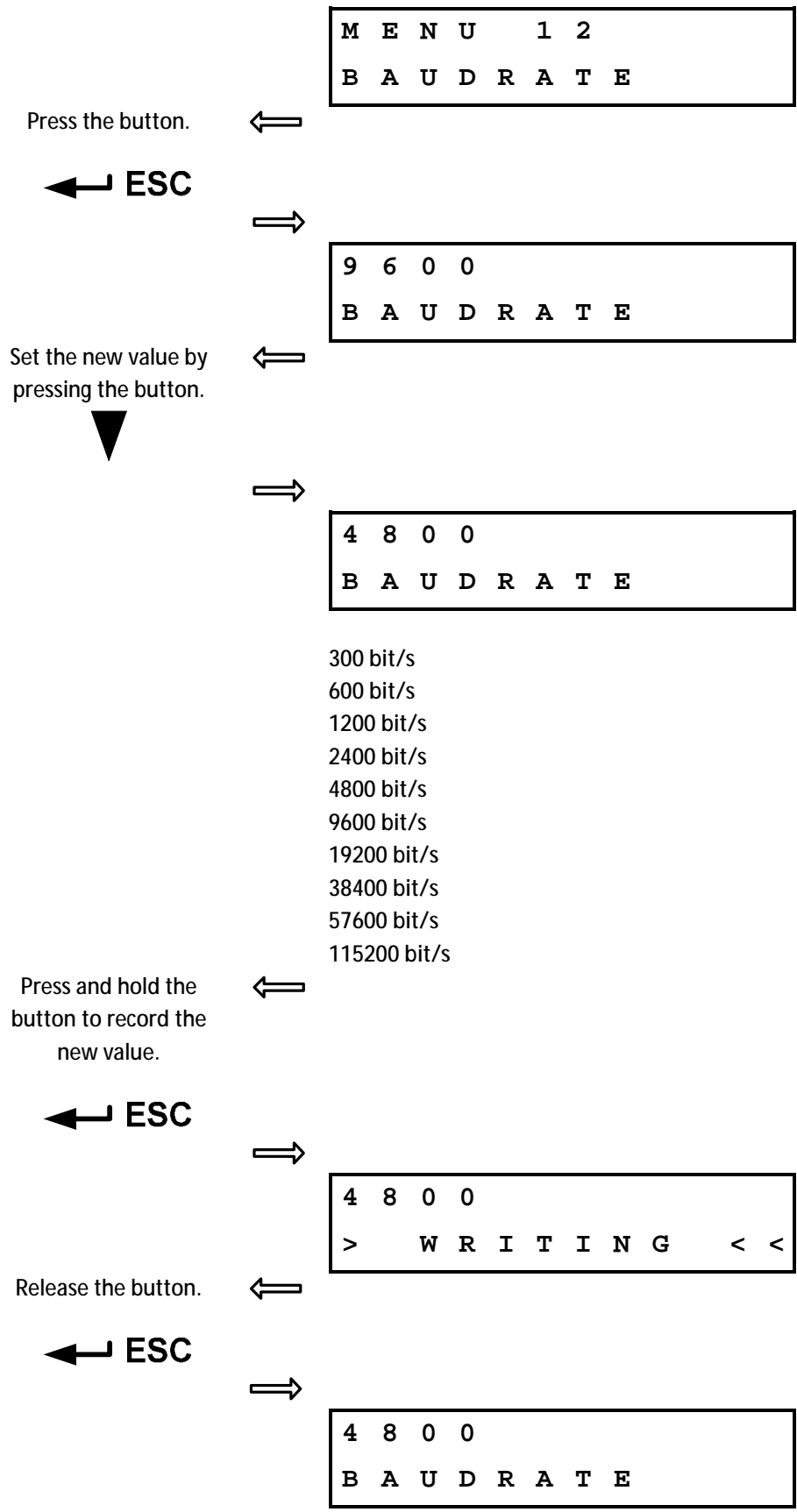

2.10.16. MENU 12 (for Profibus version)– Address 2

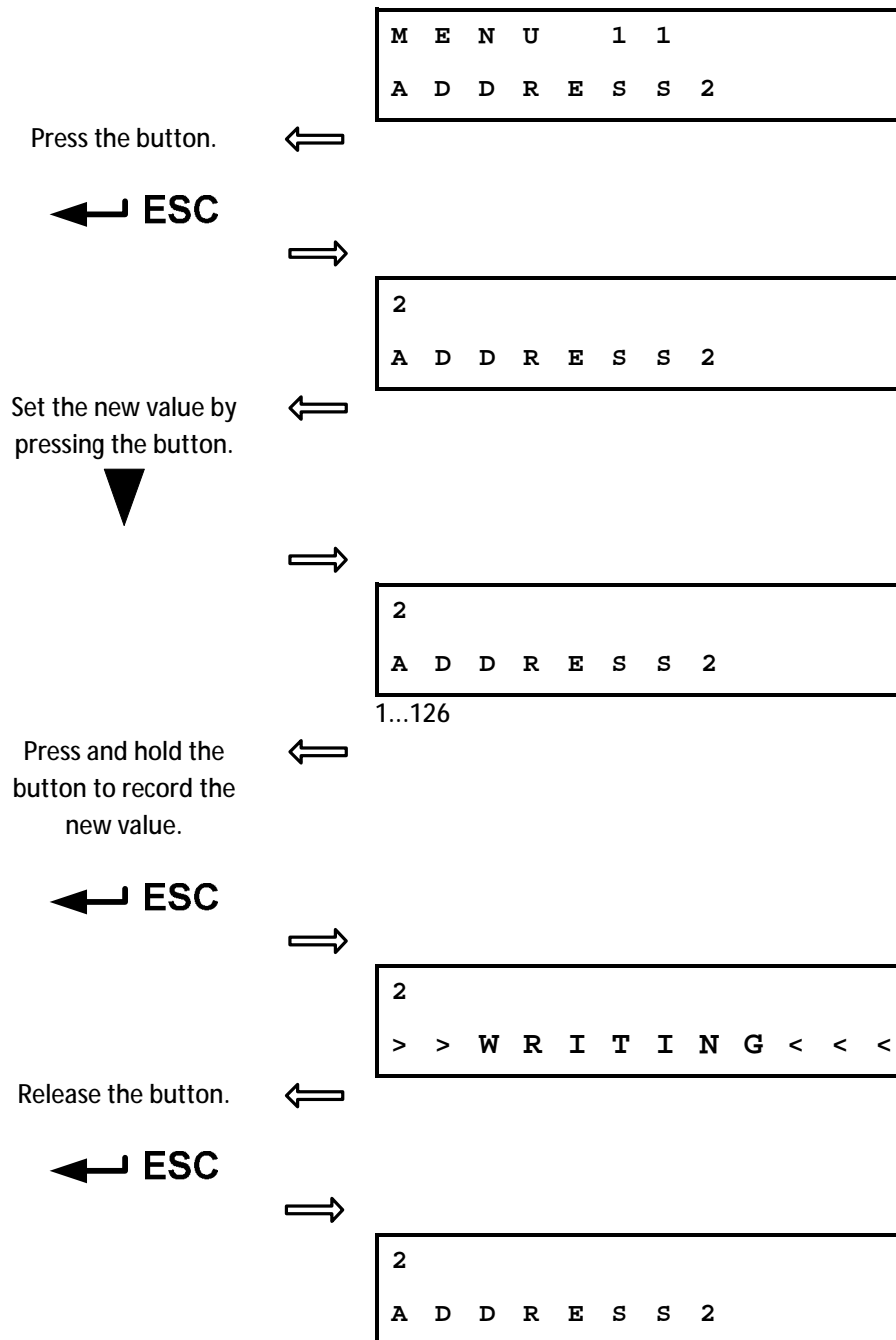

2.10.17. MENU 13 (for DMS 3 version) – Analog control signal

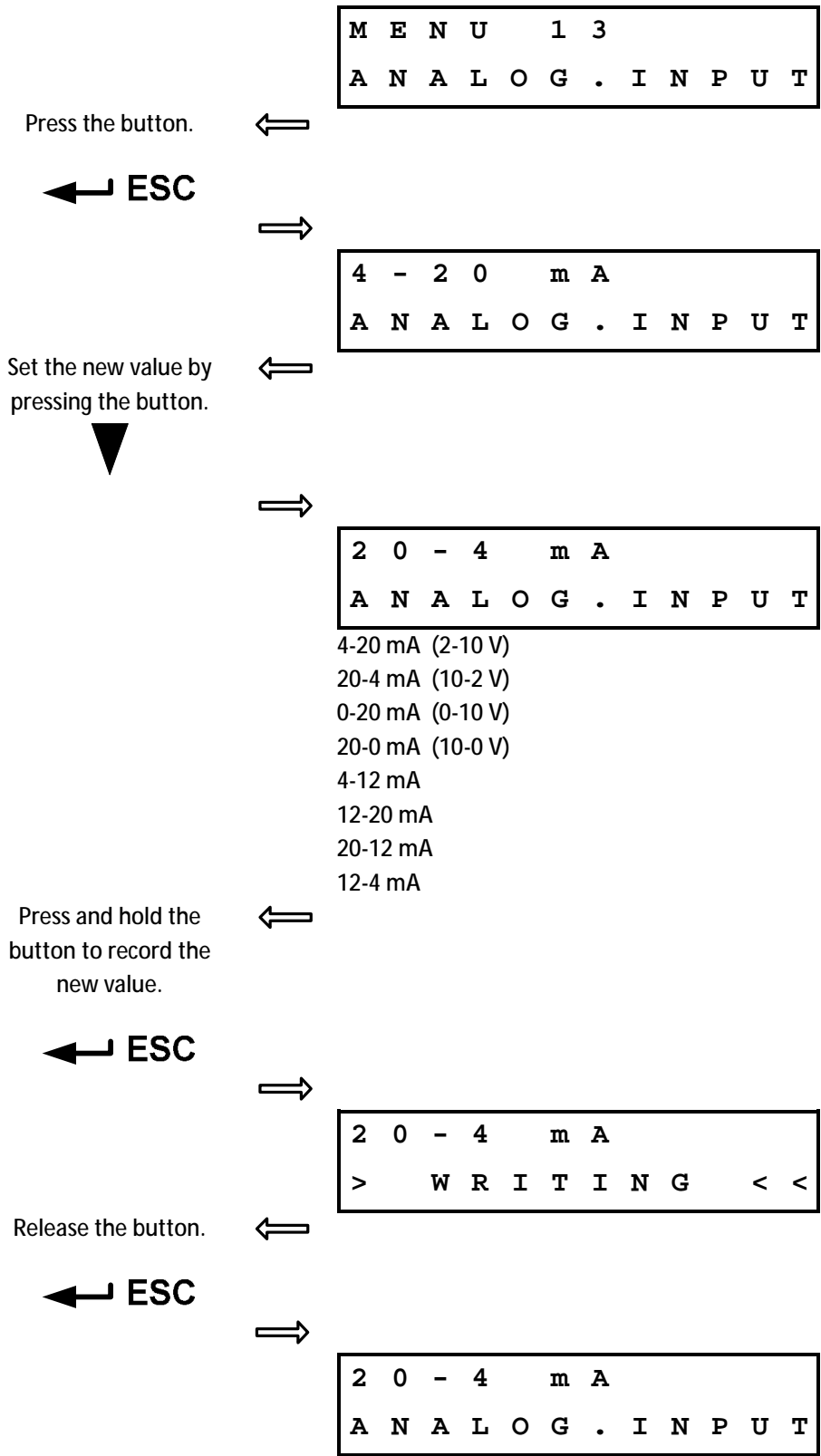

2.10.18. MENU 13 (for Modbus version) – Parity

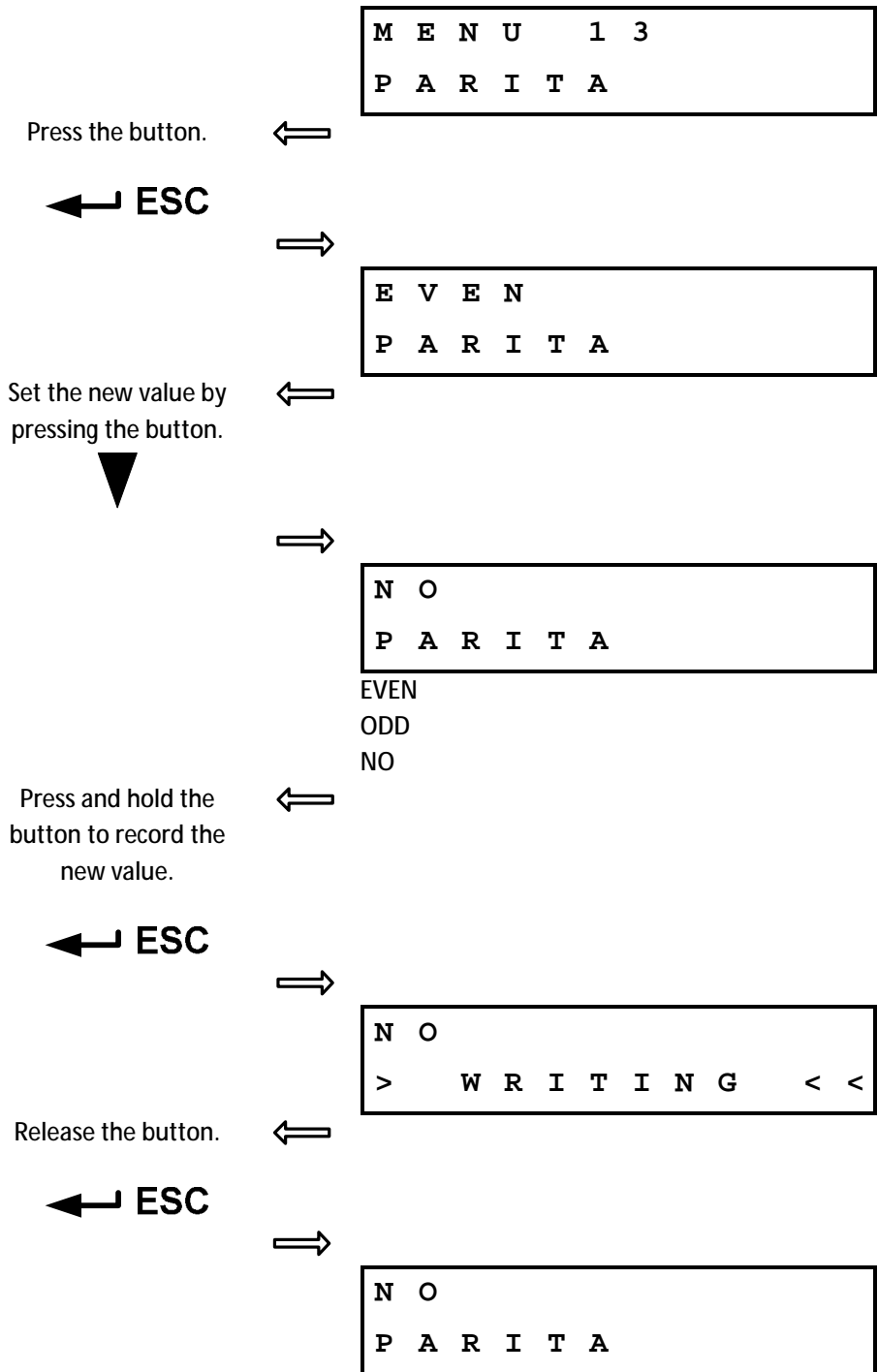

2.10.19. MENU 13 (for Profibus version) – Redundancia

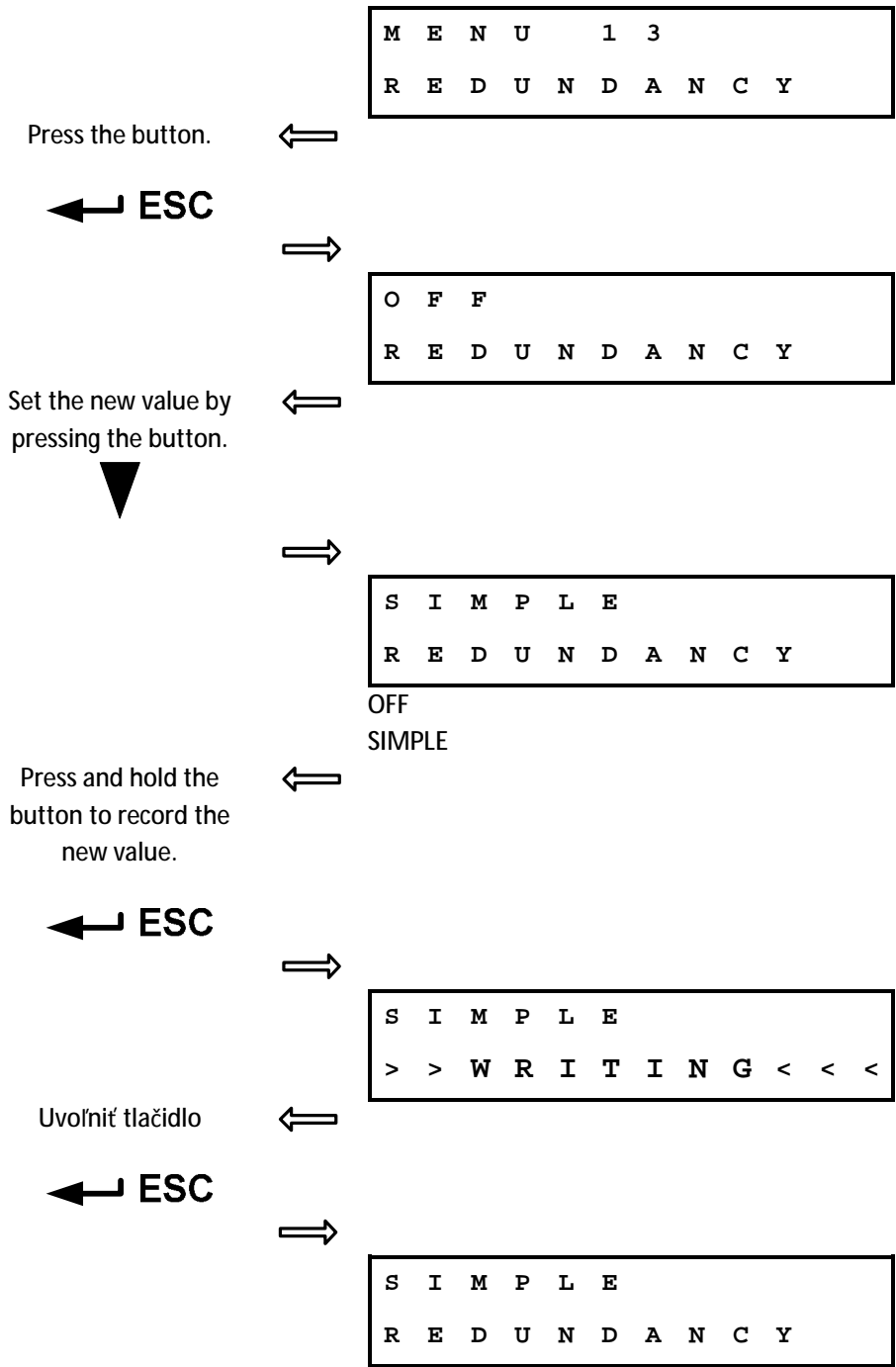

2.10.20. MENU 14 (for DMS 3 version and Profibus version), resp. MENU 16 (for Modbus version) – Dead zone

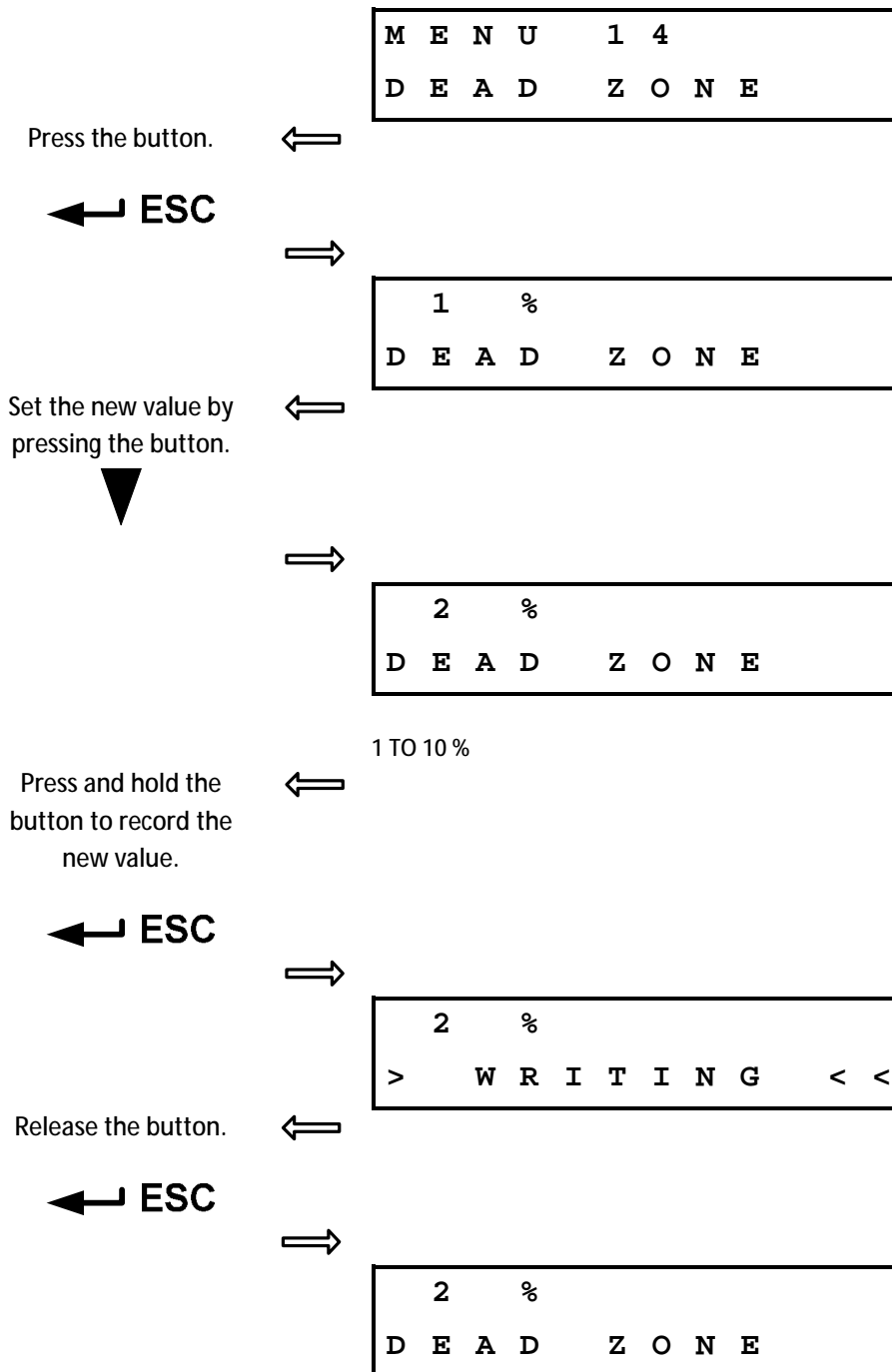

2.10.21. (for MODBUS version) – Redundancy

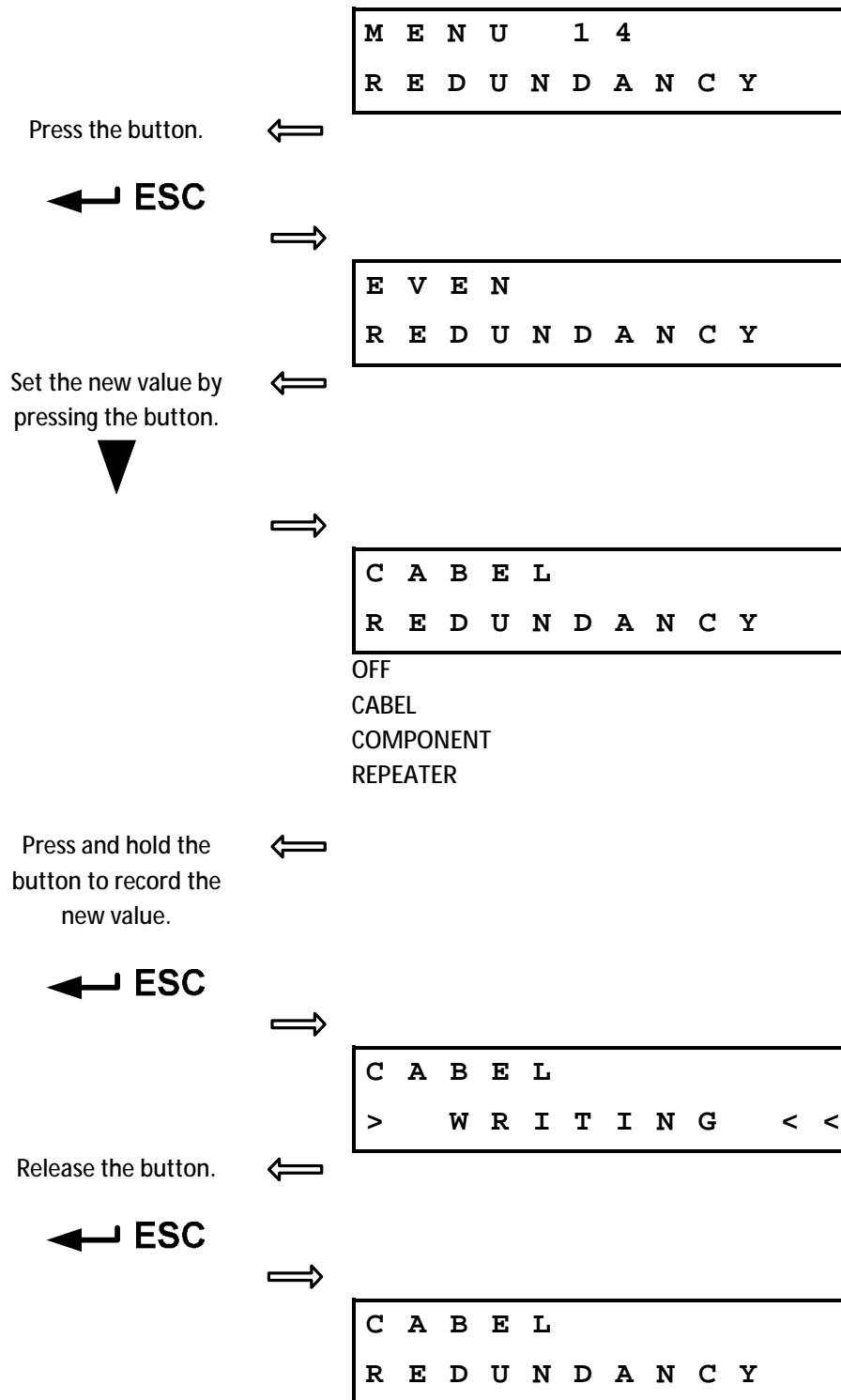

2.10.22. MENU 15 (for DMS 3 version and Profibus version), resp. MENU 17 (for Modbus version) – Internal dead zone

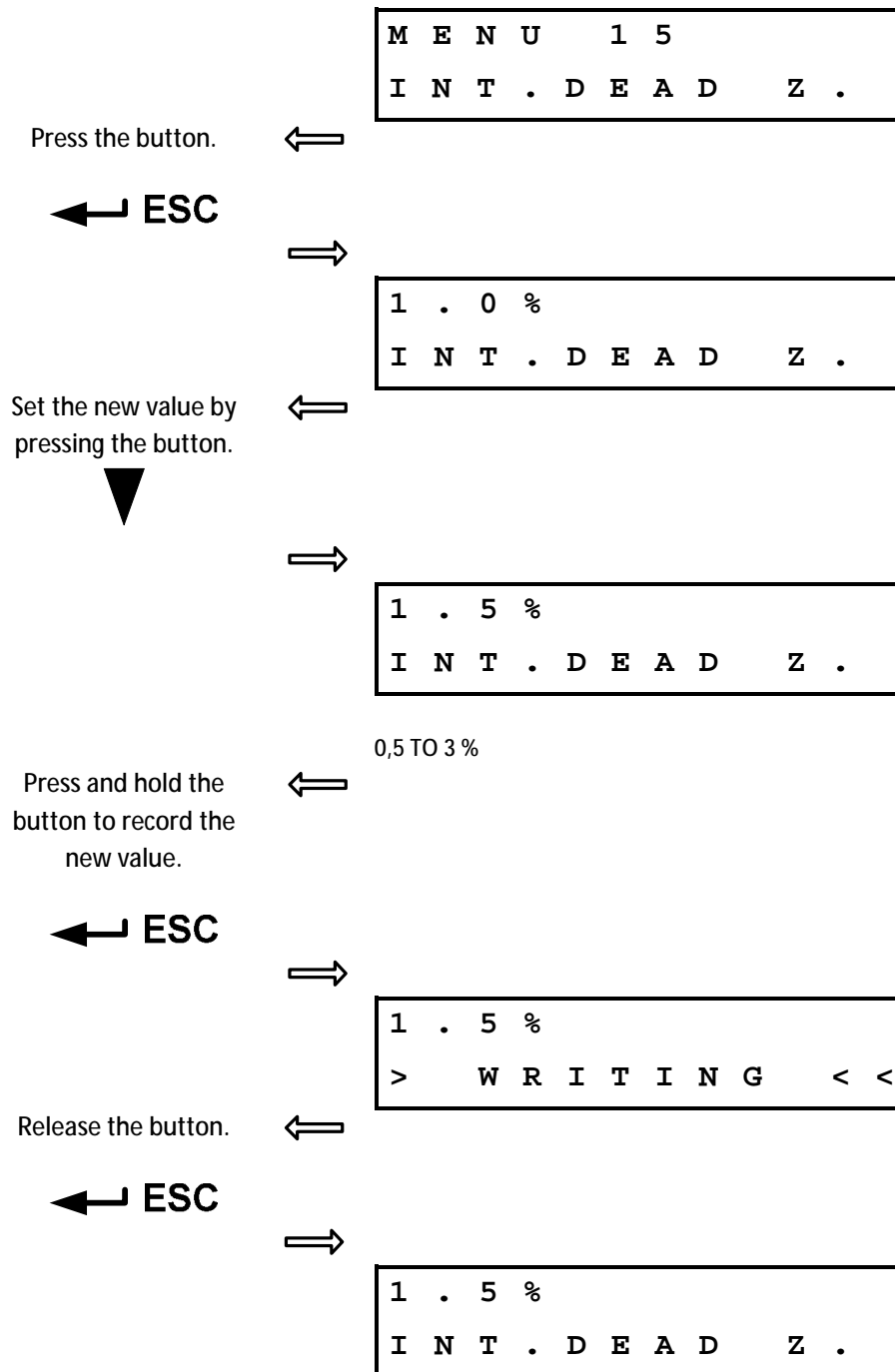

2.10.23. MENU 15 (for MODBUS version) – Connection check time

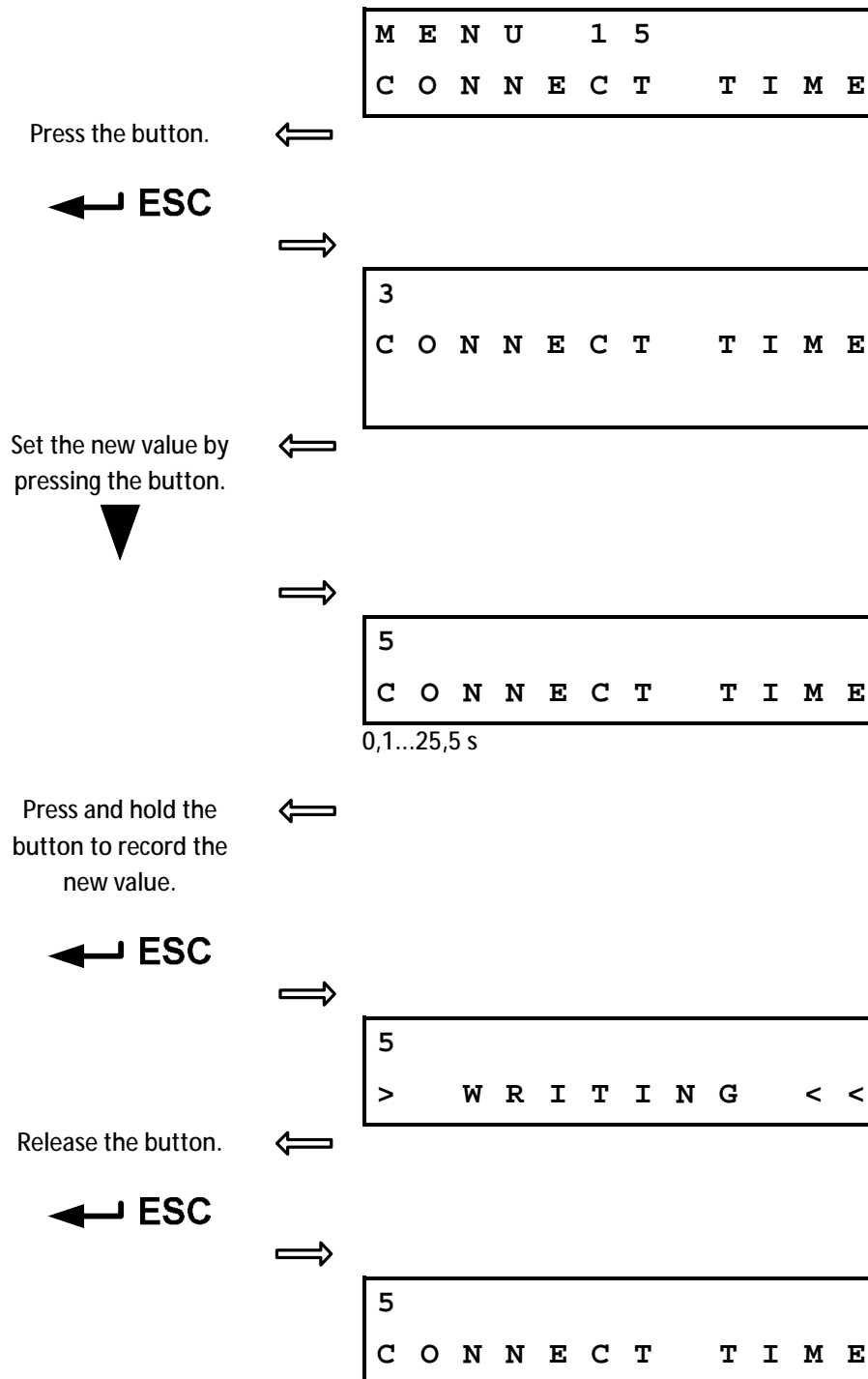

2.10.24. MENU 16 (for DMS 3 version and Profibus version), resp. MENU 18 (for Modbus version) – Failure reaction

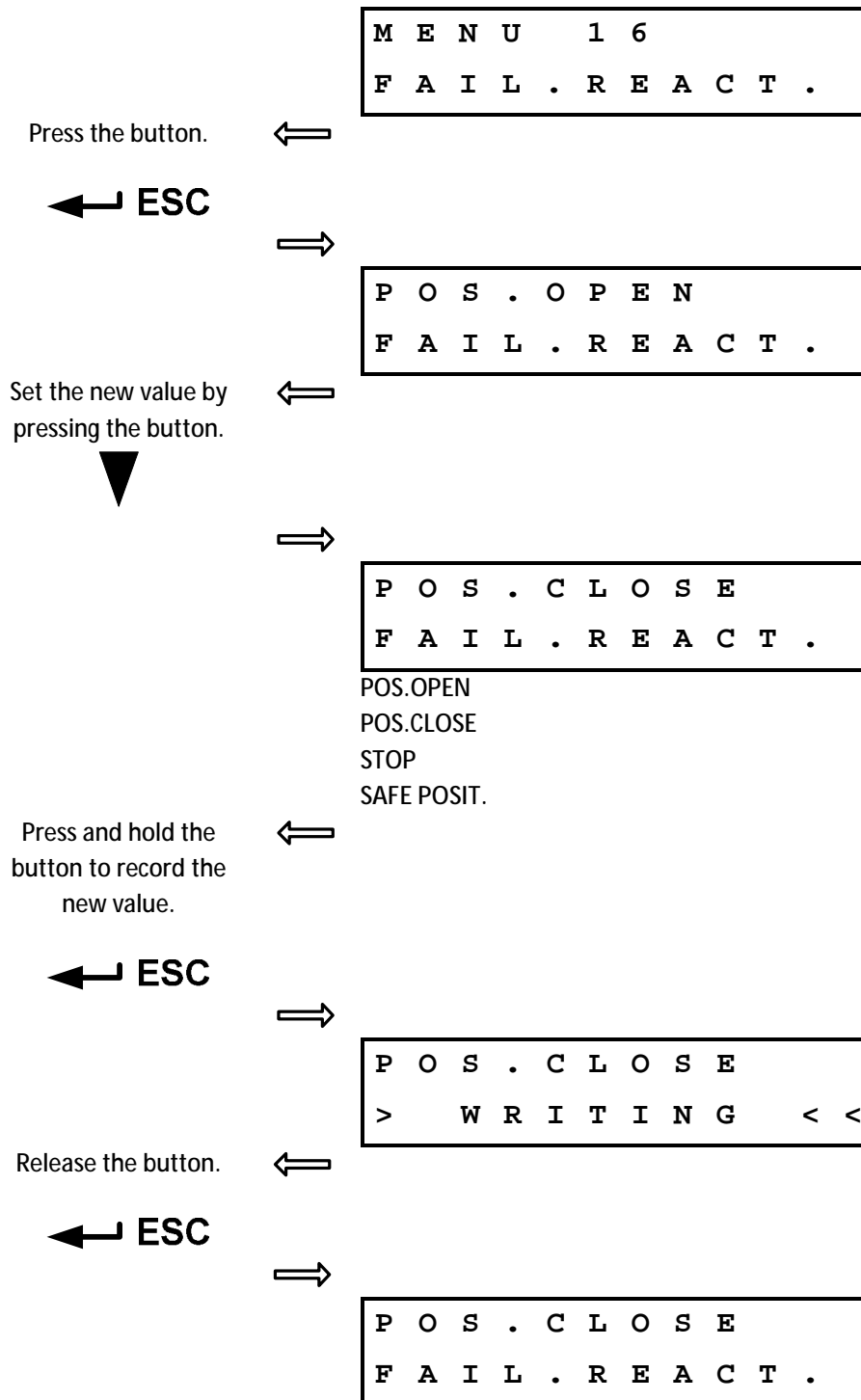

2.10.25. MENU 17 (for DMS 3 version and Profibus version), resp. MENU 19 (for Modbus version) – Safe position

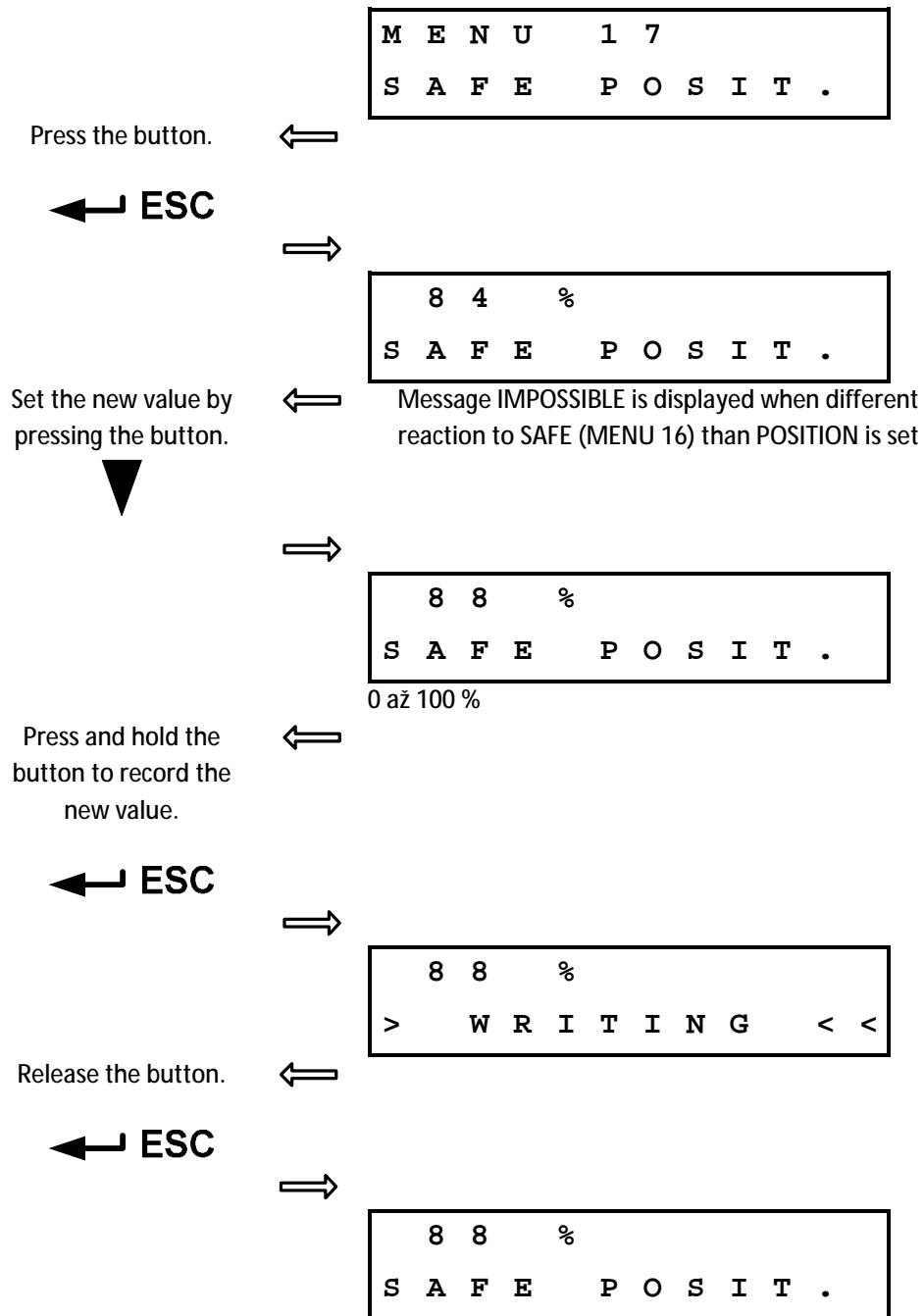

2.10.26. MENU 18 (for DMS 3 version and Profibus version), resp. MENU 20 (for Modbus version) – Function of input I1

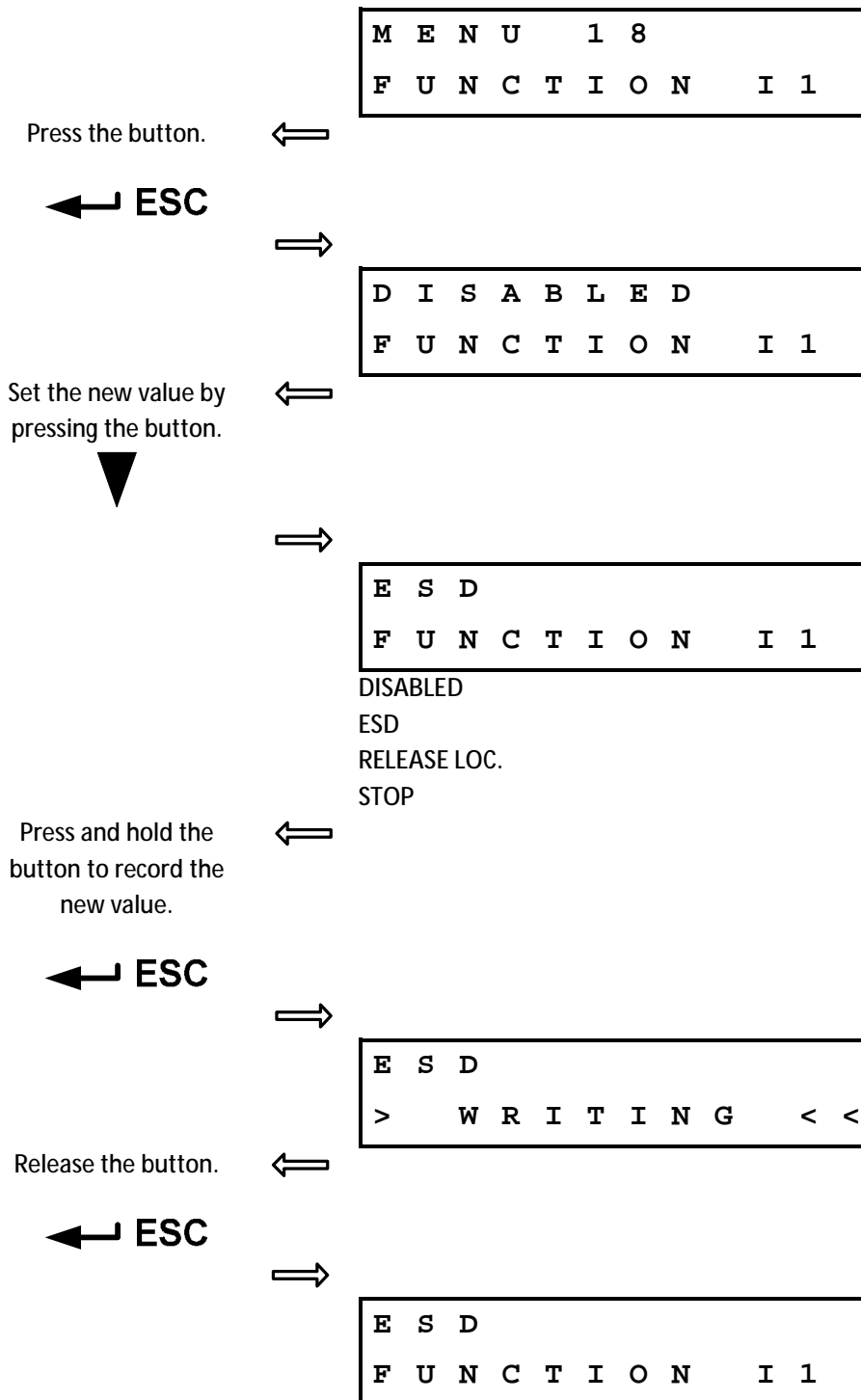

2.10.27. MENU 19 (for DMS 3 version and Profibus version), resp. MENU 21 (for Modbus version) – Active level of input I1

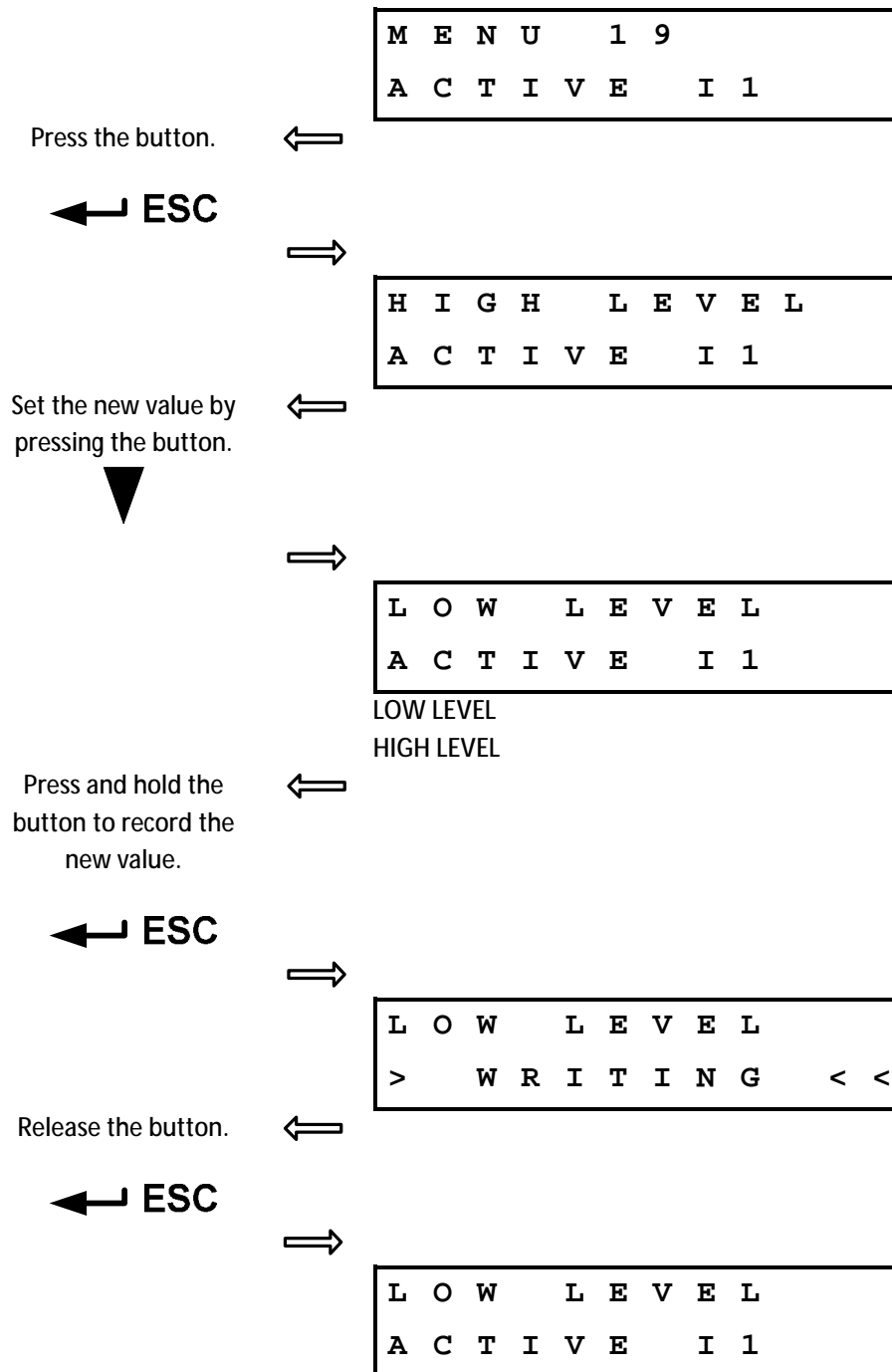

2.10.28. MENU 20 (for DMS 3 version and Profibus version), resp. MENU 22 (for Modbus version) – Function of input I2

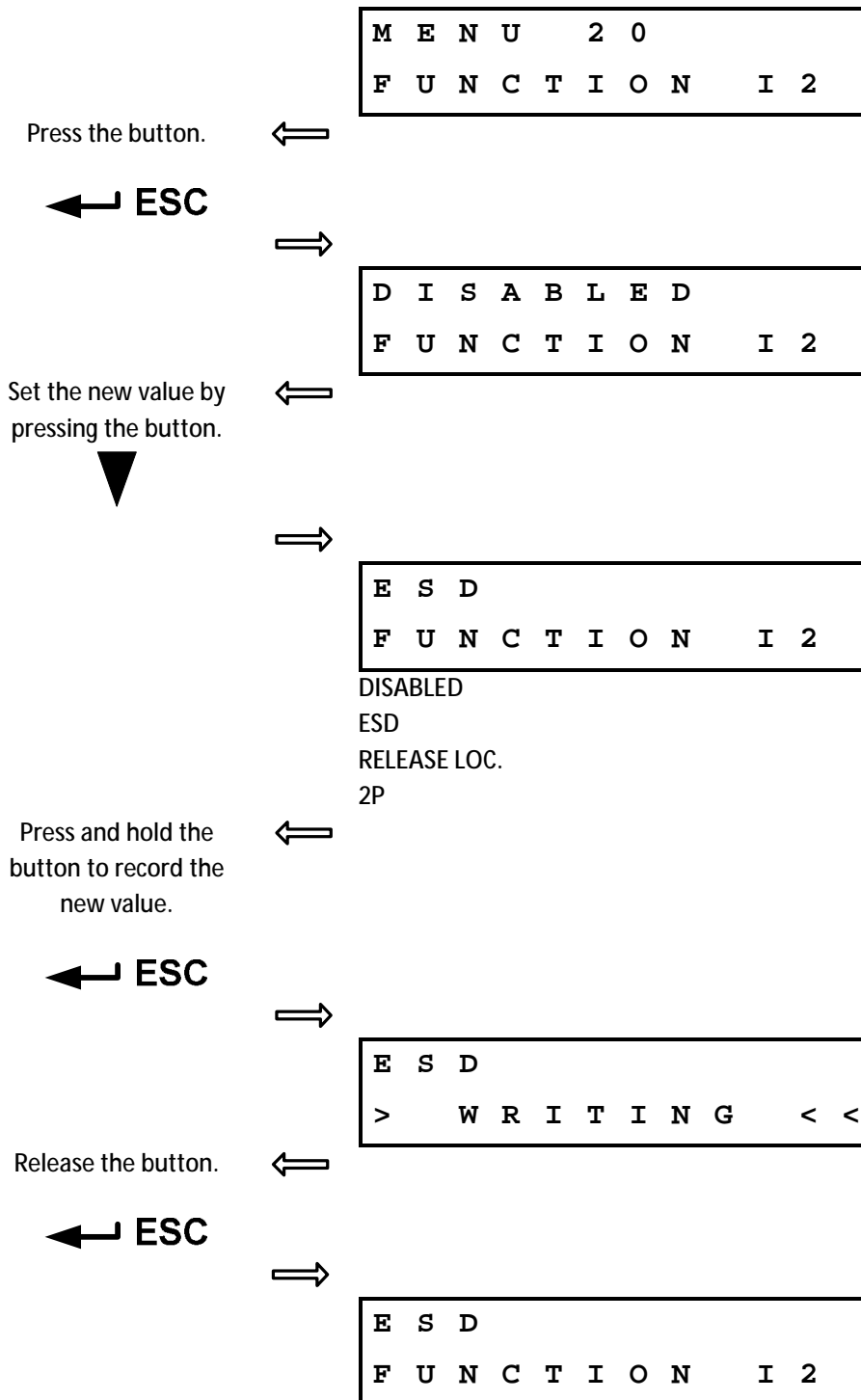

2.10.29. MENU 21 (for DMS 3 version and Profibus version), resp. MENU 23 (for Modbus version) – Active level of input I2

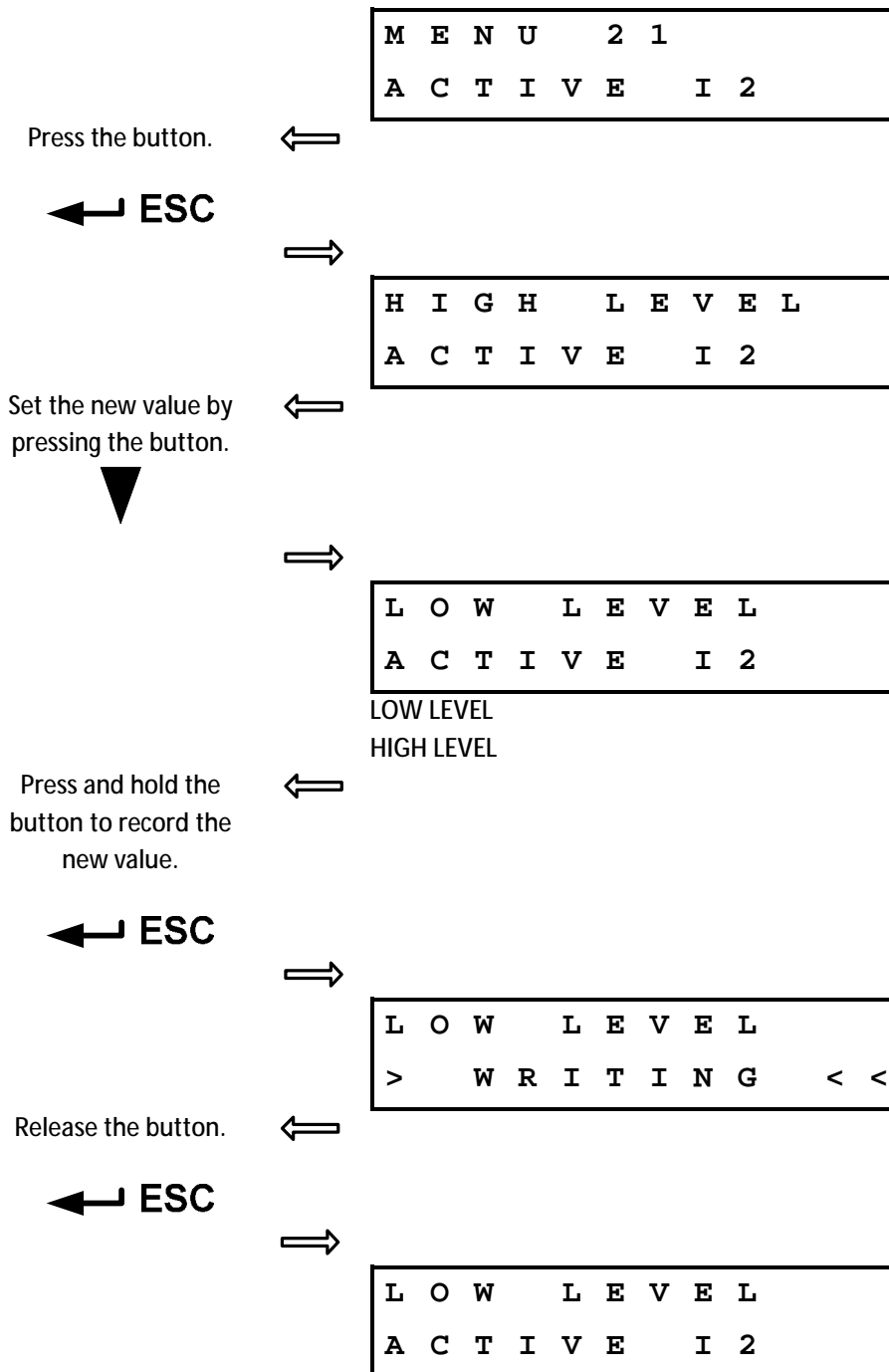

2.10.30. MENU 22 (for DMS 3 version and Profibus version), resp. MENU 24 (for Modbus version) – Thermal fuse by the reaction on failure

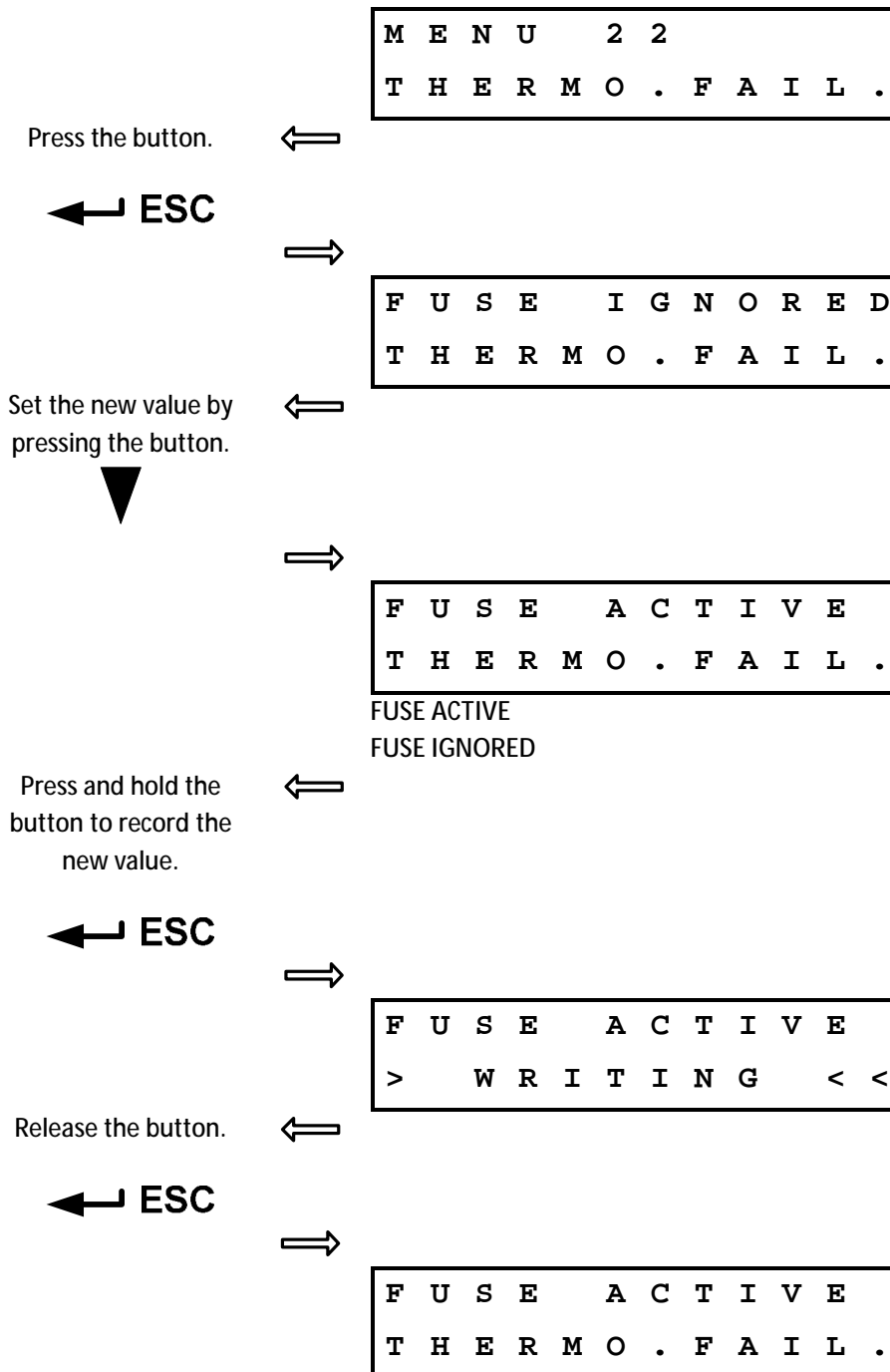

2.10.31. MENU 23 (for DMS 3 version and Profibus version), resp. MENU 25 (for Modbus version) – Overheating deactivation

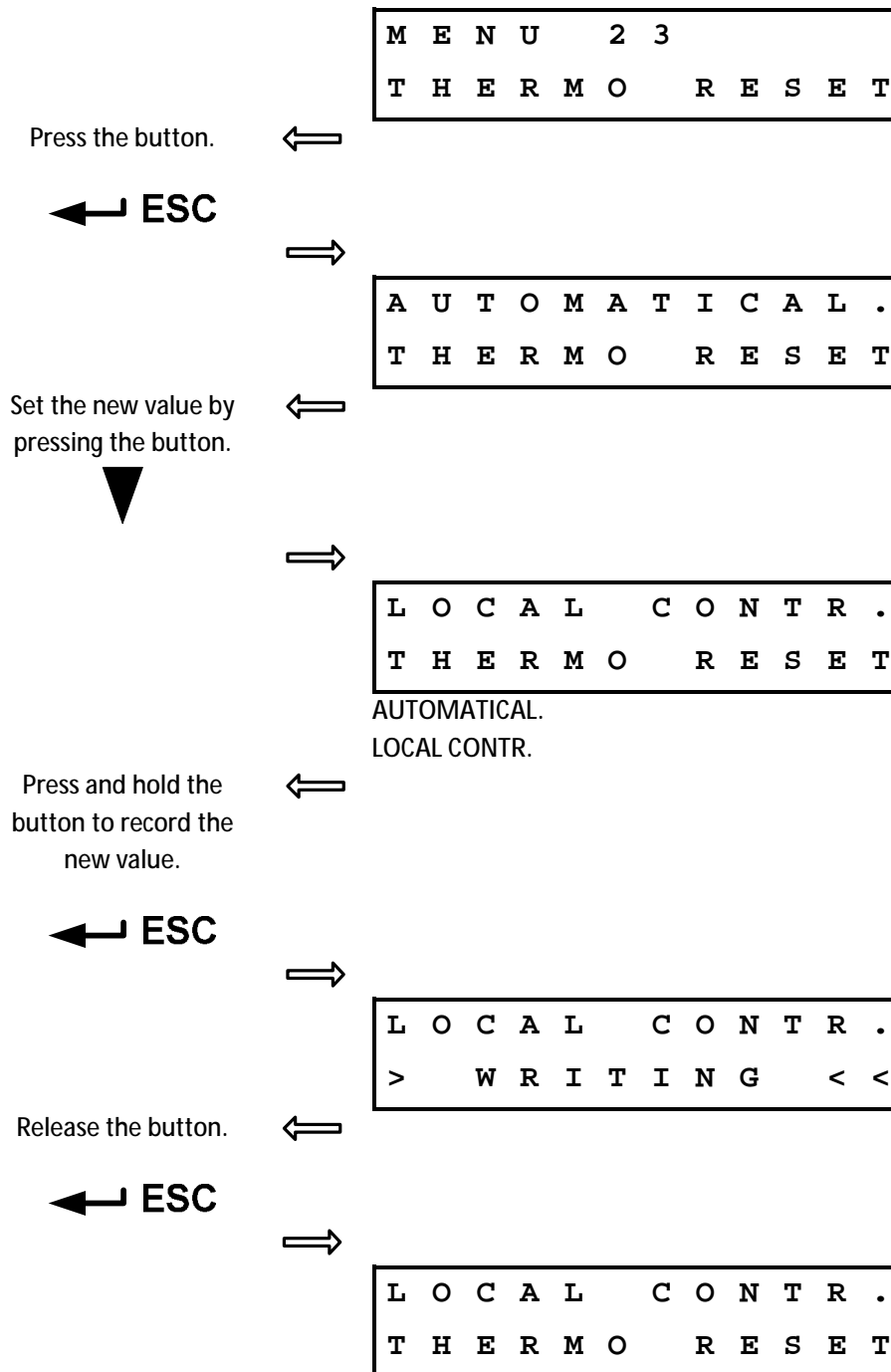

2.10.32. MENU 24 (for DMS 3 version and Profibus version), resp. MENU 26 (for Modbus version) – Function of relay ready

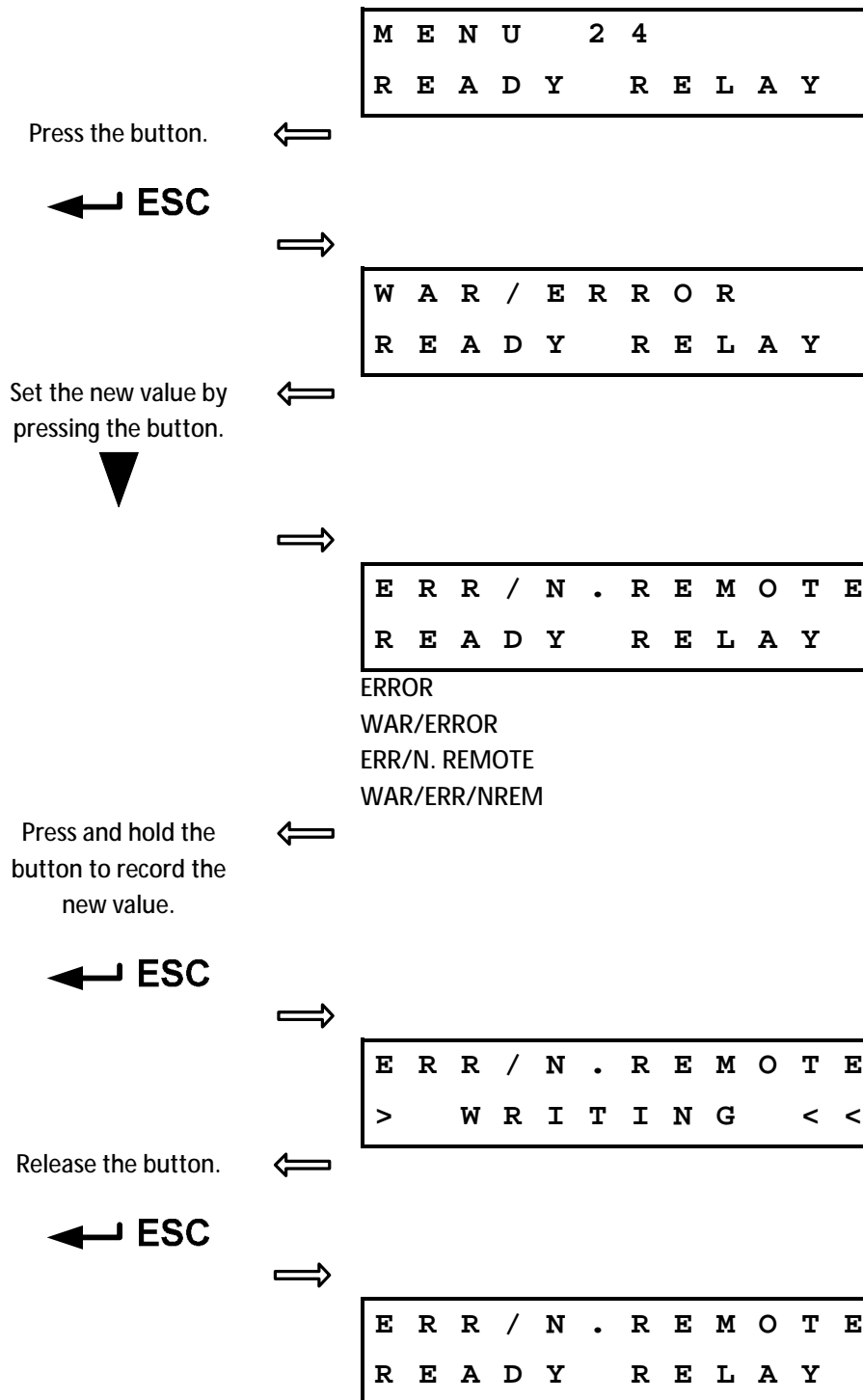

2.10.33. MENU 25, 27, 29, 31, 33 (for DMS 3 version and Profibus version), resp. MENU 27,29,31,33,35 (for Modbus version) – Function of relay 1 ... 5

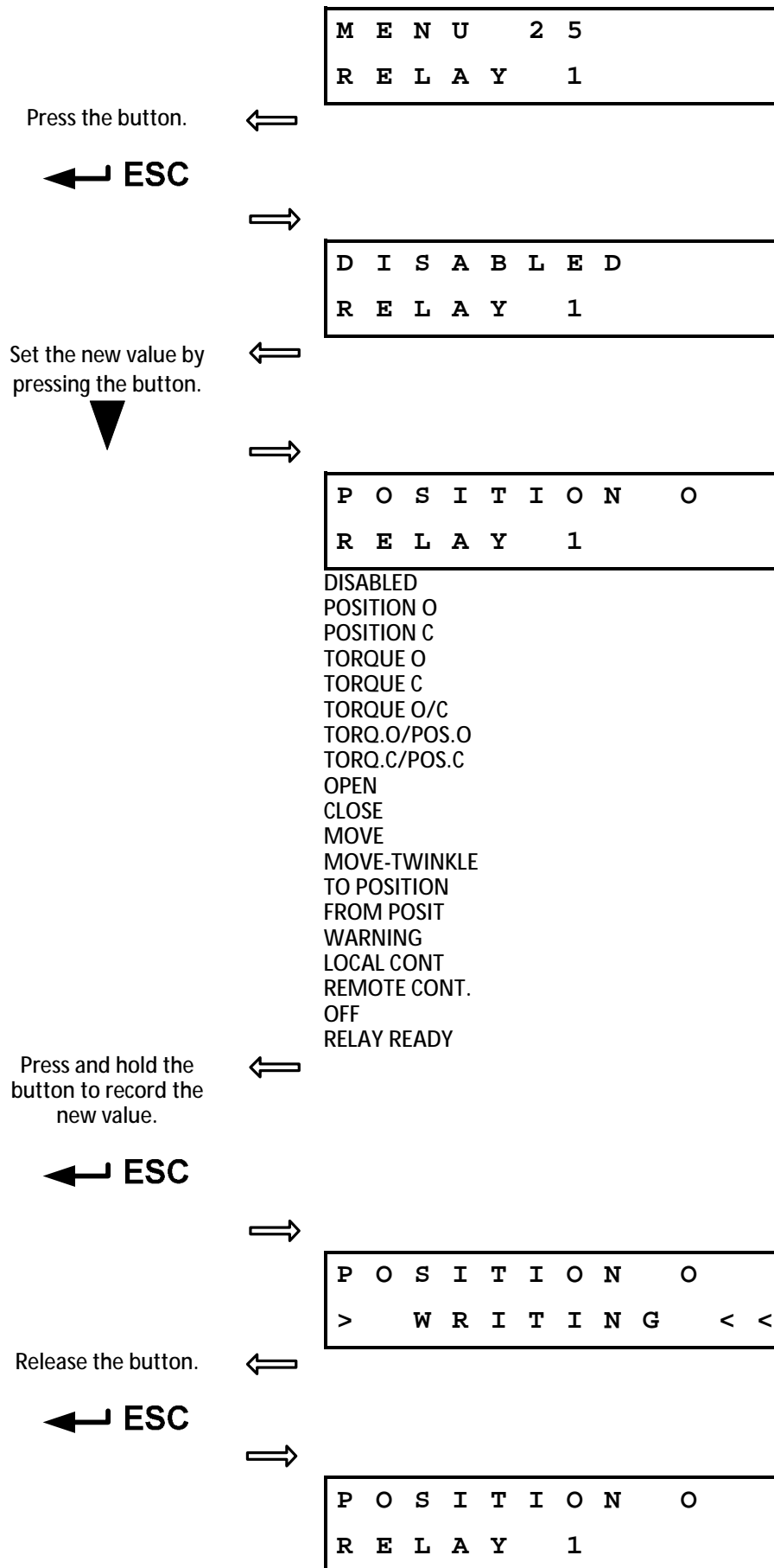

2.10.34. MENU 26, 28, 30, 32, 34 (for DMS 3 version and Profibus version), resp. MENU 28,30,32,34,36 (for Modbus version) – Position for Relay 1 ... 5

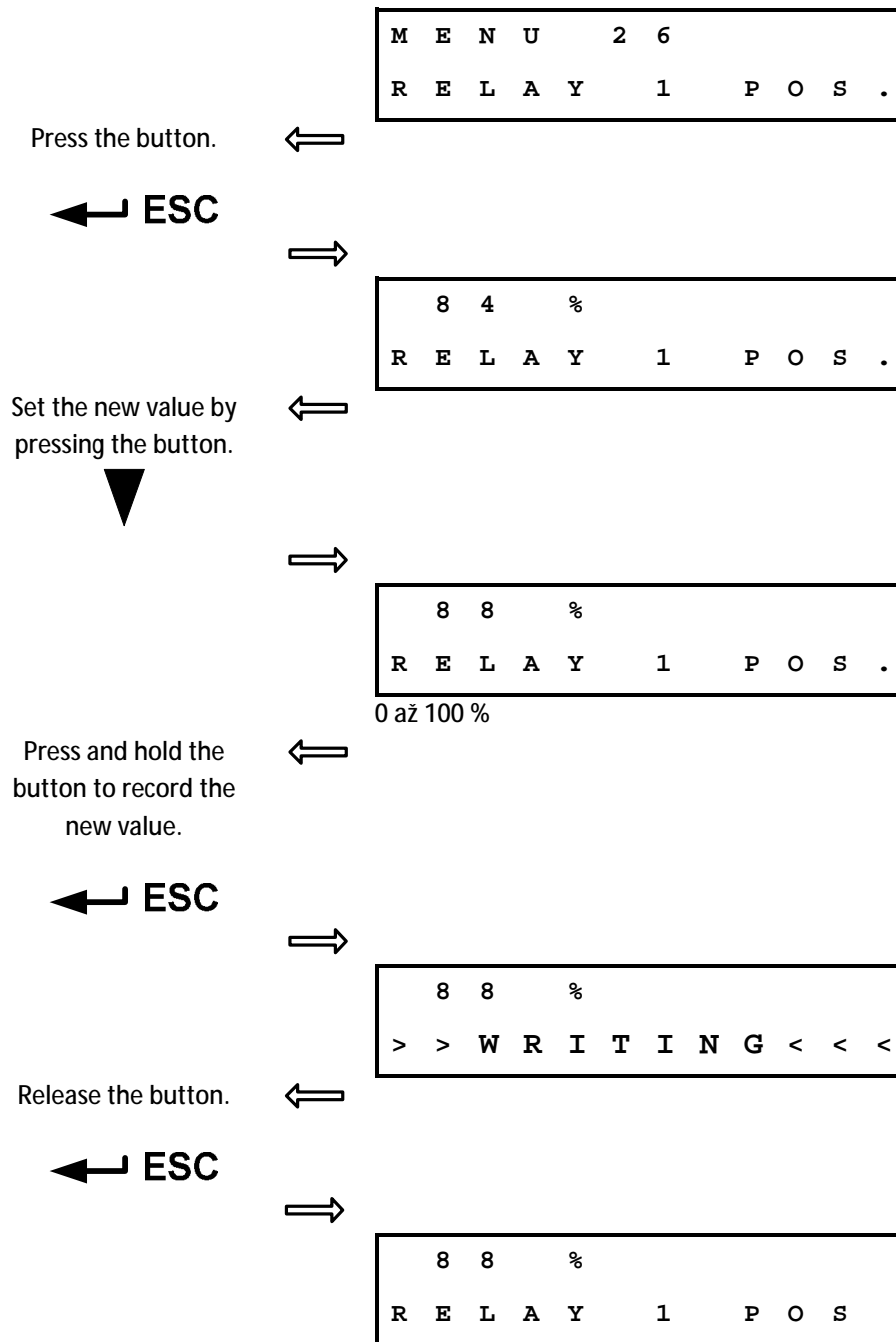

2.10.35. MENU 35 (for DMS 3 version and Profibus version), resp. MENU 37 (for Modbus version) – Cycle mode

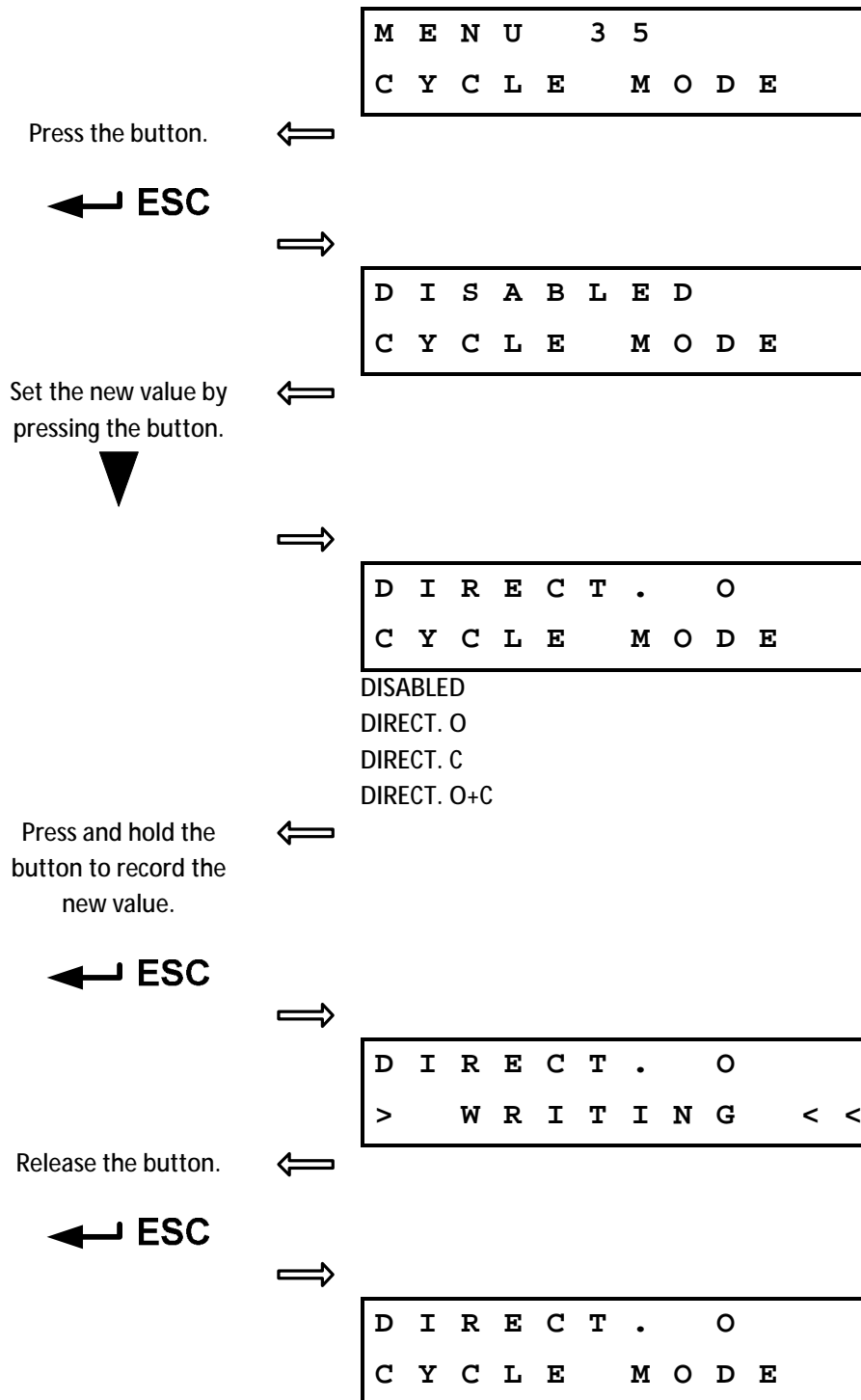

2.10.36. MENU 36 (for DMS 3 version and Profibus version), resp. MENU 38 (for Modbus version) – Time of run of motor when cycle mode is enabled

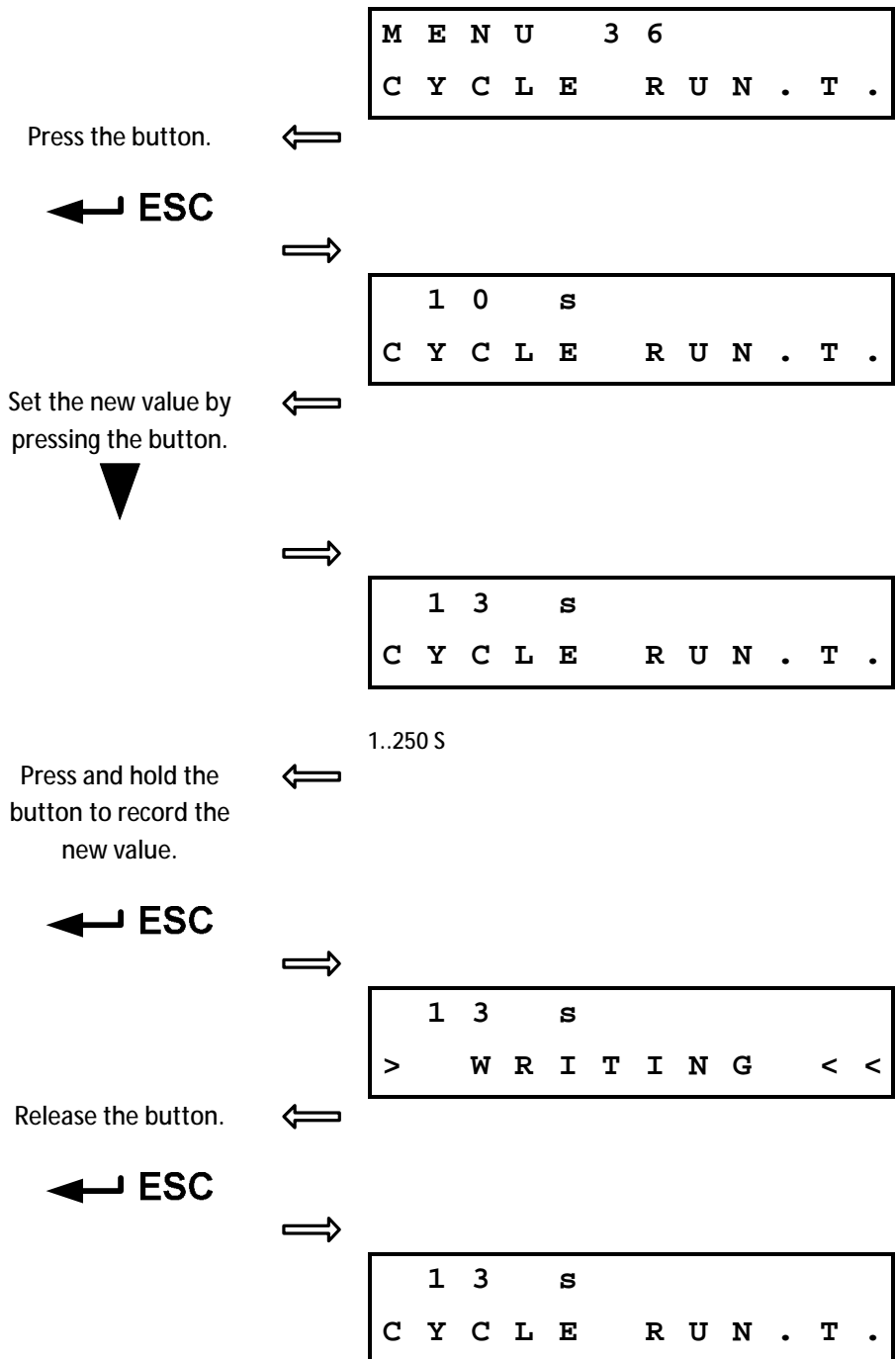

2.10.37. MENU 37 (for DMS 3 version and Profibus version), resp. MENU 39 (for Modbus version) – Time of pause of motor when cycle mode is enabled

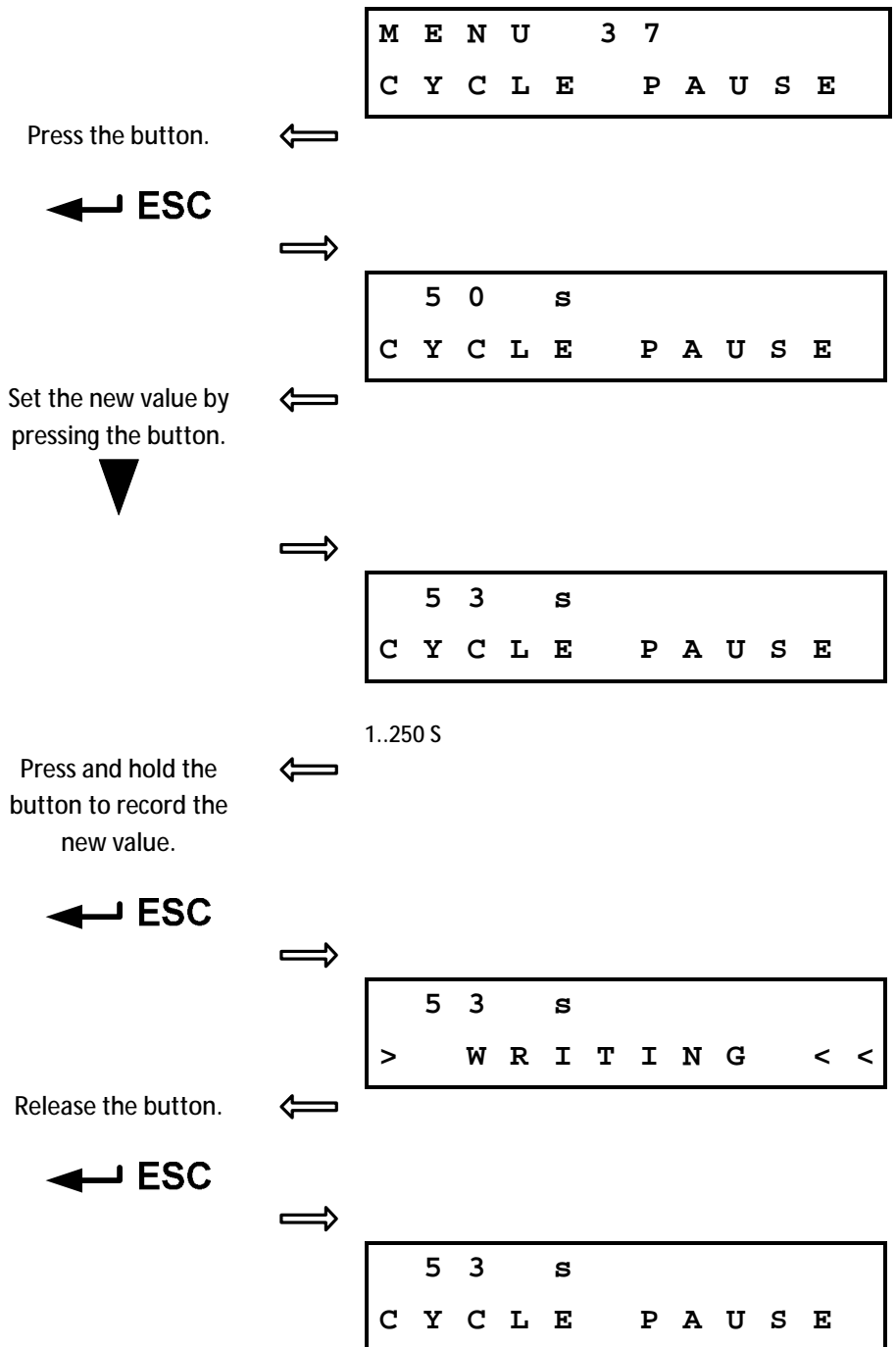

2.10.38. MENU 38 (for DMS 3 version and Profibus version), resp. MENU 40 (for Modbus version) – Tolerance O and C

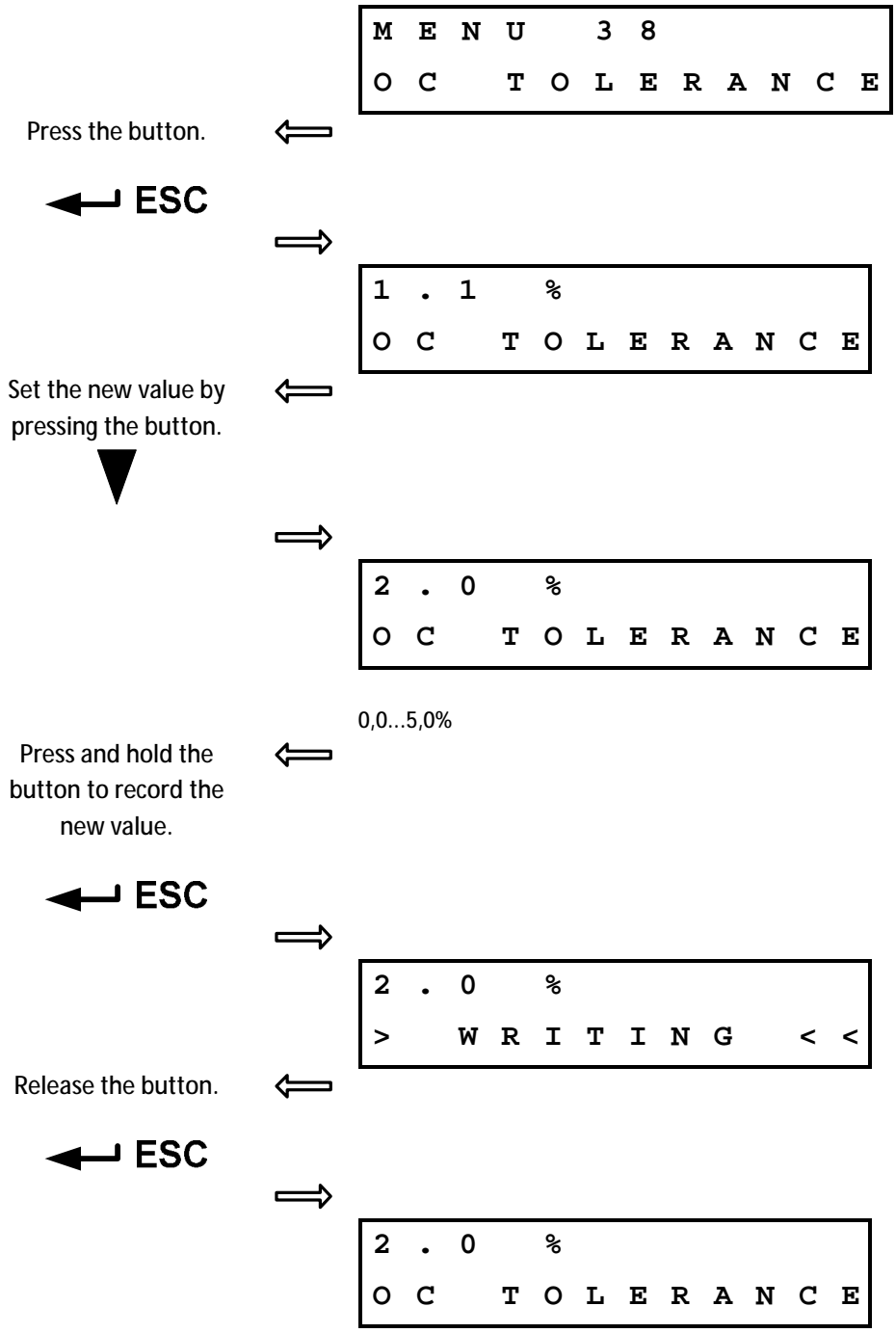

2.10.39. MENU 39 (for DMS 3 version and Profibus version), resp. MENU 41 (for Modbus version) – Information of system

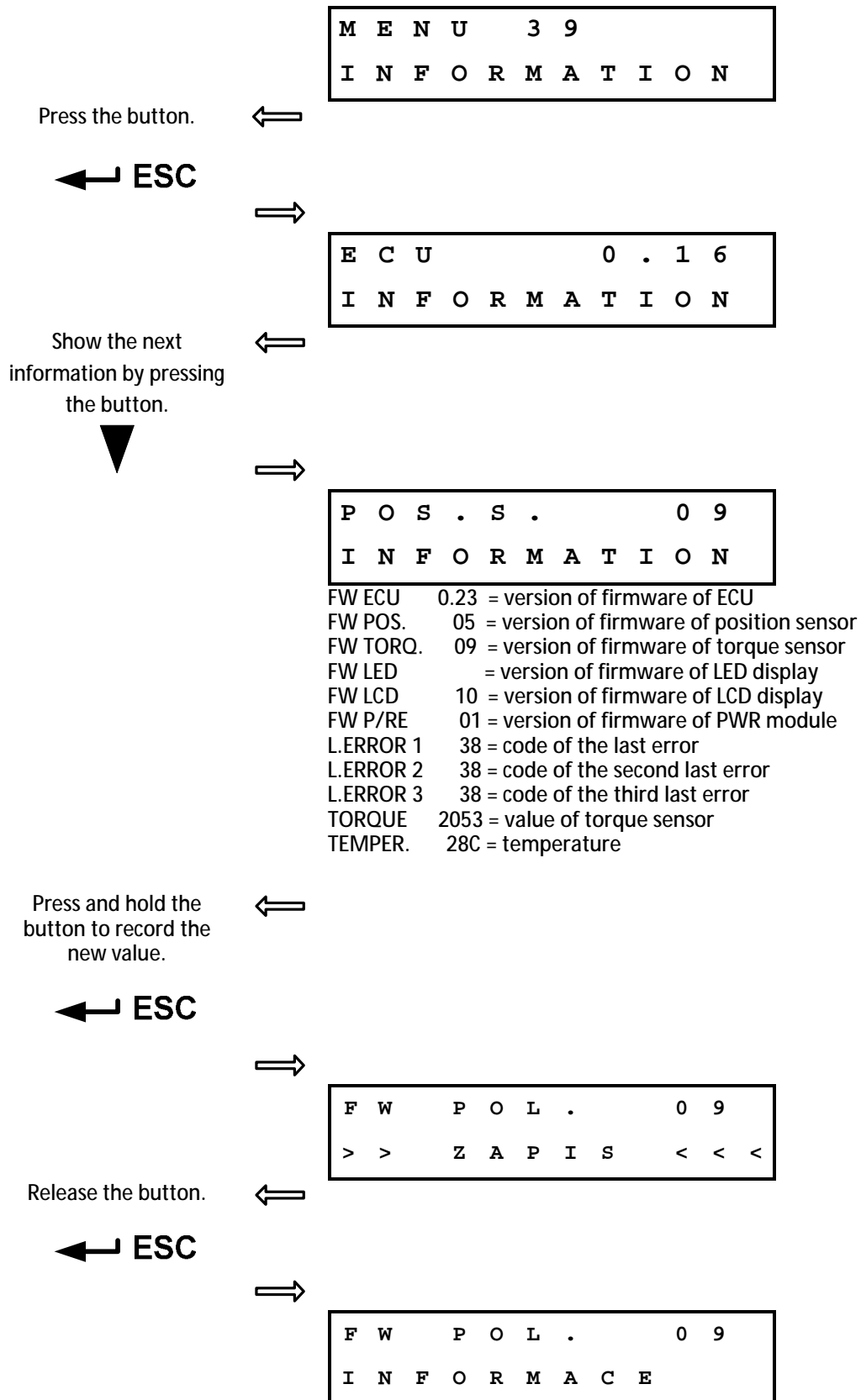

2.10.40. MENU 40 (for DMS 3 version and Profibus version), resp. MENU 42 (for Modbus version) – Restore parameters from backup

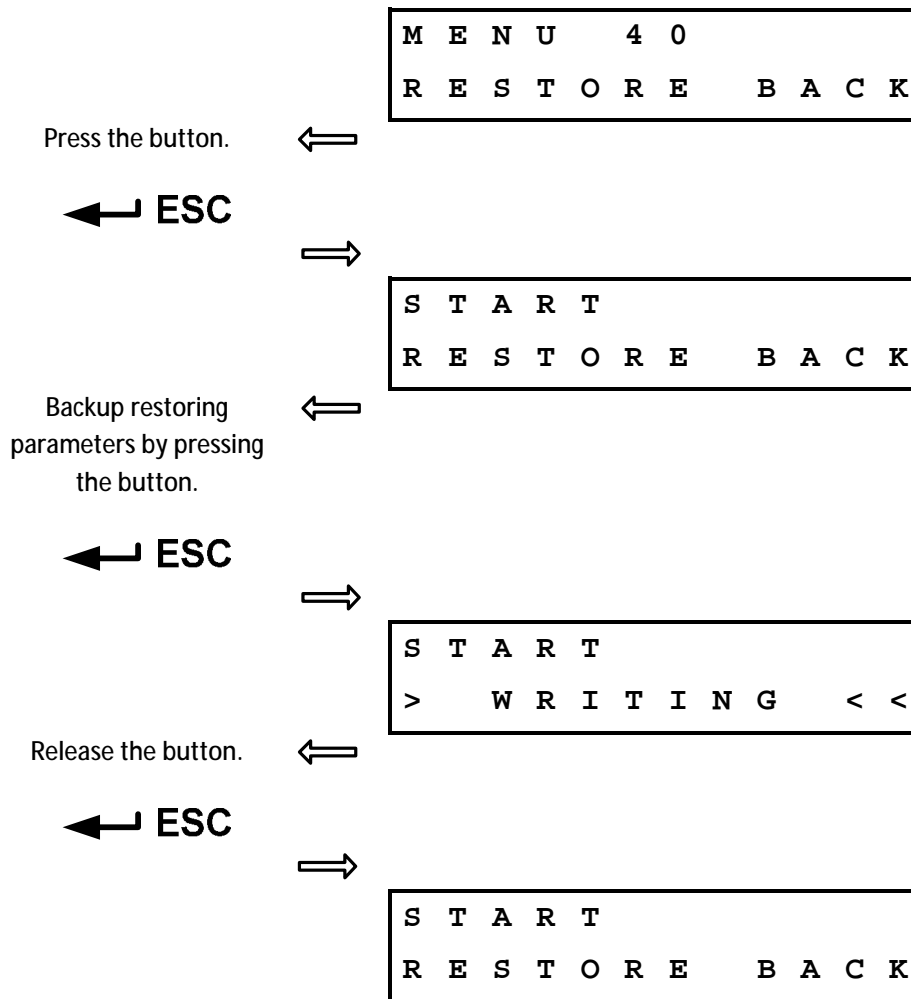

2.10.41. MENU 41 (for DMS 3 version and Profibus version), resp. MENU 43 (for Modbus version) – The creation of backup parameters

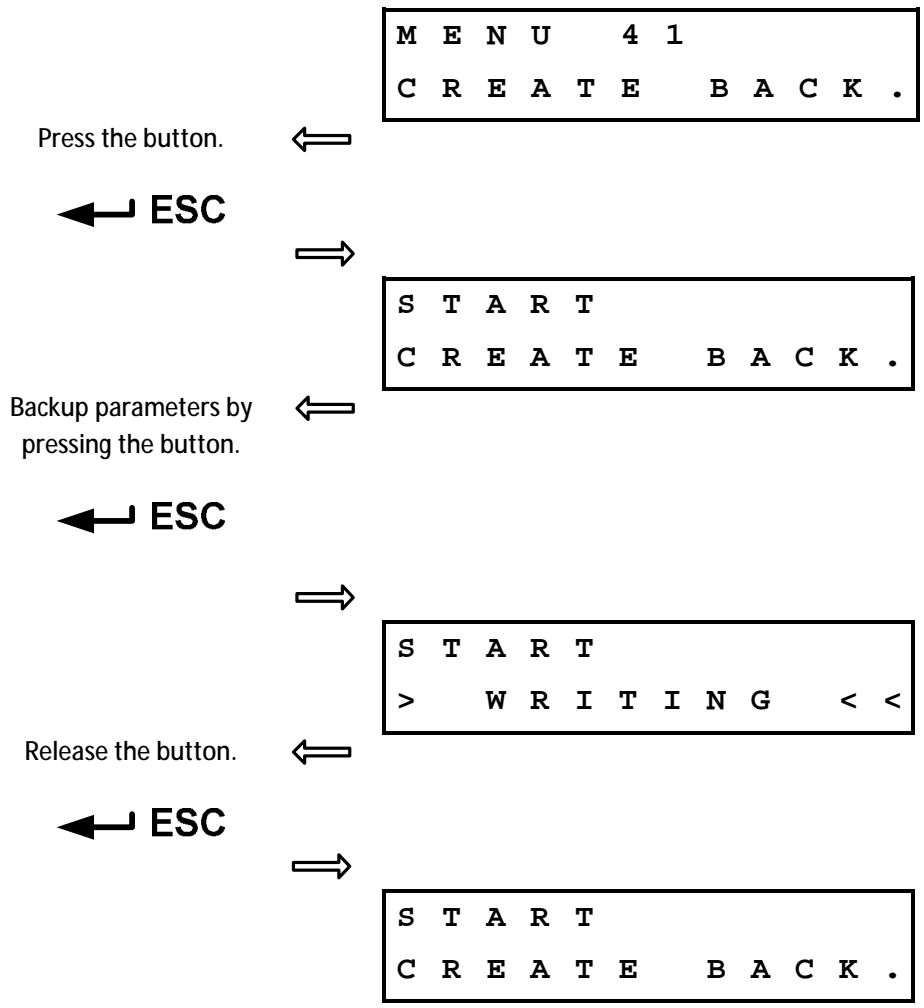

2.10.42. MENU 42 (for DMS 3 version and Profibus version), resp. MENU 44 (for Modbus version) – Restoring factories setup

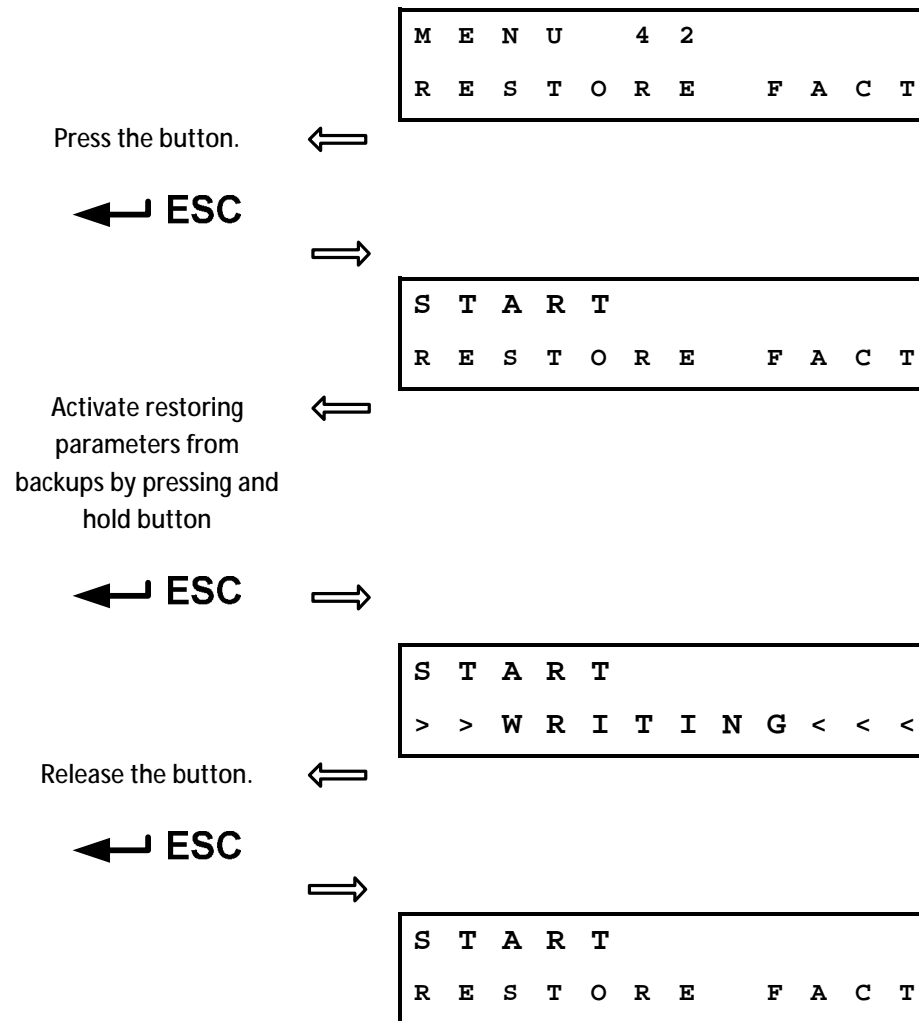

2.10.43. MENU 43 (for DMS 3 version and Profibus version), resp. MENU 45 (for Modbus version) – Resetting active errors

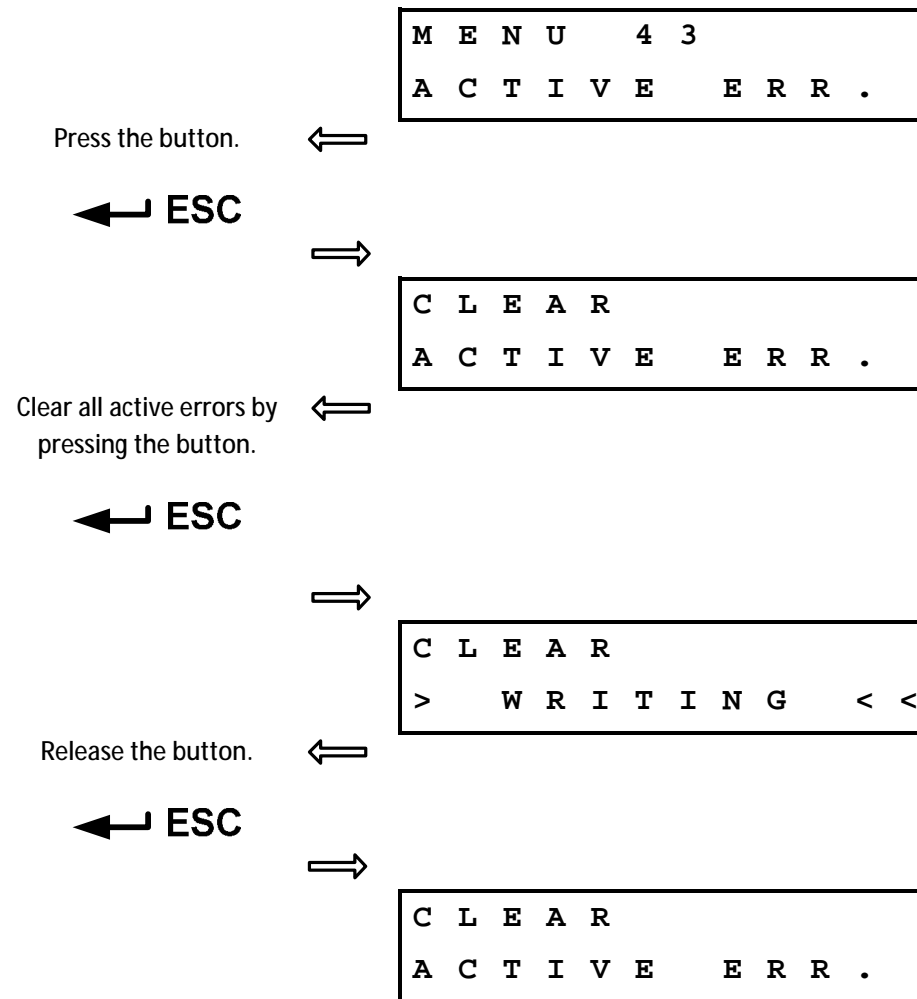

2.10.44. MENU 44 (for DMS 3 version and Profibus version), resp. MENU 46 (for Modbus version) – Actuator dir

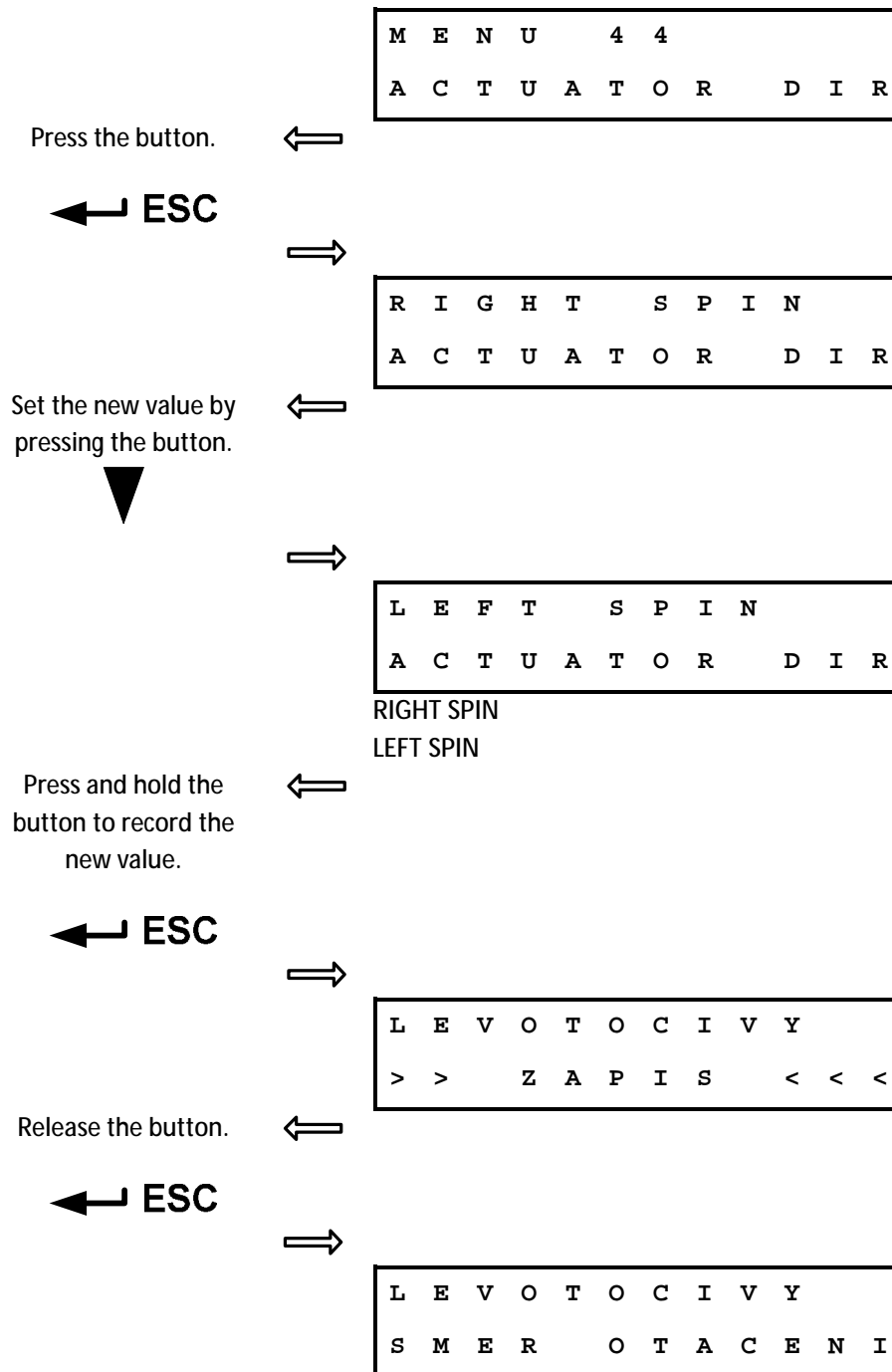

3. REGISTER ERRORS AND WARNINGS

A list of errors and alarms is contained in Annex No. 74 1053 02.

REGADA, s.r.o.
Strojnícka 7
080 01 Prešov
Slovak Republic

Tel.: +421 (0)51 7480 460
Fax: +421 (0)51 7732 096
E-mail: regada@regada.sk
www.regada.sk