

INDEX / INDICE

VALVES AND SOLENOID VALVES / VALVOLE ED ELETTROVALVOLE G1/8

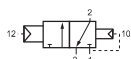

V32V1P618

SINGLE PNEUMATIC PILOT - INTERNAL PRESSURE RETURN
COMANDO PNEUMATICO - MOLLA PNEUMATICA

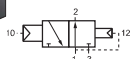

V32V1P918

SINGLE PNEUMATIC PILOT - INTERNAL PRESSURE RETURN
COMANDO PNEUMATICO - MOLLA PNEUMATICA

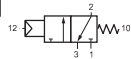

V32V1P6M8

SINGLE PNEUMATIC PILOT - SPRING RETURN
COMANDO PNEUMATICO - MOLLA MECCANICA

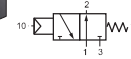

V32V1P9M8

SINGLE PNEUMATIC PILOT - SPRING RETURN
COMANDO PNEUMATICO - MOLLA MECCANICA

pag. B-24

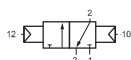

V32V2P018

DOUBLE PNEUMATIC PILOT
DOPPIO COMANDO PNEUMATICO

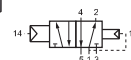
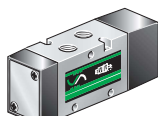

V52V1P018

SINGLE PNEUMATIC PILOT - INTERNAL PRESSURE RETURN
COMANDO PNEUMATICO - MOLLA PNEUMATICA

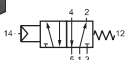

V52V1PM18

SINGLE PNEUMATIC PILOT - SPRING RETURN
COMANDO PNEUMATICO - MOLLA MECCANICA

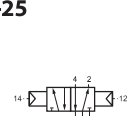

V52V2P018

DOUBLE PNEUMATIC PILOT
DOPPIO COMANDO PNEUMATICO

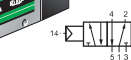
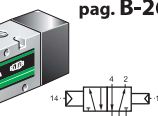

V52V2PD18

..... WITH DIFFERENTIAL
..... CON DIFFERENZIALE

pag. B-25

pag. B-26

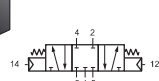

V53V2P618

DOUBLE PNEUMATIC PILOT - CENTER POSITION CLOSED
DOPPIO COMANDO PNEUMATICO - CENTRI CHIUSI

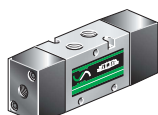

V53V2P918

DOUBLE PNEUMATIC PILOT - CENTER POSITION OPEN
DOPPIO COMANDO PNEUMATICO - CENTRI APERTI

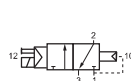
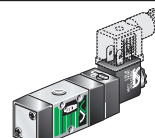

E32W1S618 -

SINGLE SOLENOID VALVE - INTERNAL PRESSURE RETURN
COMANDO ELETTROPNEUMATICO - MOLLA PNEUMATICA

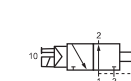
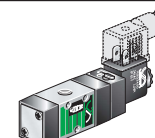

E32W1S918 -

SINGLE SOLENOID VALVE - INTERNAL PRESSURE RETURN
COMANDO ELETTROPNEUMATICO - MOLLA PNEUMATICA

pag. B-27

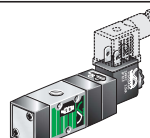

E32W1S6M8 -

SINGLE SOLENOID VALVE - SPRING RETURN
COMANDO ELETTROPNEUMATICO - MOLLA MECCANICA

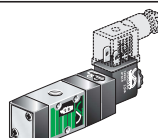

E32W1S9M8 -

SINGLE SOLENOID VALVE - SPRING RETURN
COMANDO ELETTROPNEUMATICO - MOLLA MECCANICA

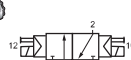
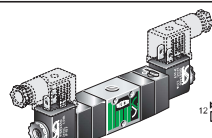

E32W2S018 -

DOUBLE SOLENOID VALVE
DOPPIO COMANDO ELETTROPNEUMATICO

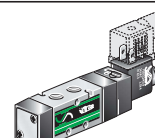

E52W1S018 -

SINGLE SOLENOID VALVE - INTERNAL PRESSURE RETURN
COMANDO ELETTROPNEUMATICO - MOLLA PNEUMATICA

pag. B-28

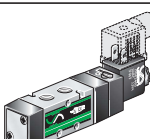

E52W1SM18 -

SINGLE SOLENOID VALVE - SPRING RETURN
COMANDO ELETTROPNEUMATICO - MOLLA MECCANICA

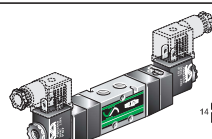

E52W2S018 -

DOUBLE SOLENOID VALVE
DOPPIO COMANDO ELETTROPNEUMATICO

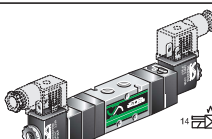

E53W2S618 -

DOUBLE SOLENOID VALVE - CENTER POSITION CLOSED
DOPPIO COMANDO ELETTROPNEUMATICO - CENTRI CHIUSI

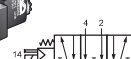
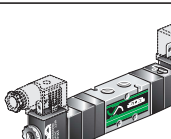

E53W2S918 -

DOUBLE SOLENOID VALVE - CENTER POSITION OPEN
DOPPIO COMANDO ELETTROPNEUMATICO - CENTRI APERTI

pag. B-29

COMPONENTS FOR ASSEMBLING AND SPARE PARTS / COMPONENTI PER L'ASSEMBLAGGIO E RICAMBI G1/8

ME .18



PCH 018

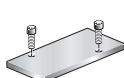

KM 018



pag. B-30

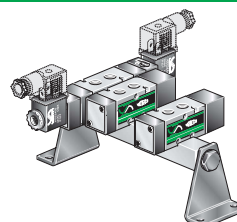

RTCOV.18
SBCOV.18
SACOV.18

pag. B-32



INDEX / INDICE

(*) ATEX versions see / Versioni ATEX vedi P. B-113

G1/4 VALVES AND SOLENOID VALVES / VALVOLE ED ELETTROVALVOLE

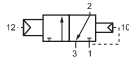

V32V1P614

SINGLE PNEUMATIC PILOT - INTERNAL PRESSURE RETURN
COMANDO PNEUMATICO - MOLLA PNEUMATICA

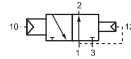

V32V1P914

SINGLE PNEUMATIC PILOT - INTERNAL PRESSURE RETURN
COMANDO PNEUMATICO - MOLLA PNEUMATICA

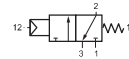

(*) **V32V1P6M4**

SINGLE PNEUMATIC PILOT - SPRING RETURN
COMANDO PNEUMATICO - MOLLA MECCANICA

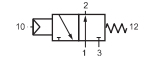

(*) **V32V1P9M4**

SINGLE PNEUMATIC PILOT - SPRING RETURN
COMANDO PNEUMATICO - MOLLA MECCANICA

pag. B-24

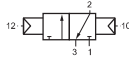

(*) **V32V2P014**

DOUBLE PNEUMATIC PILOT
DOPPIO COMANDO PNEUMATICO

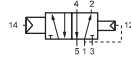

V52V1P014

SINGLE PNEUMATIC PILOT - INTERNAL PRESSURE RETURN
COMANDO PNEUMATICO - MOLLA PNEUMATICA

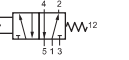
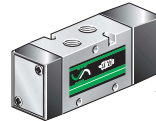

(*) **V52V1PM14**

SINGLE PNEUMATIC PILOT - SPRING RETURN
COMANDO PNEUMATICO - MOLLA MECCANICA

pag. B-25

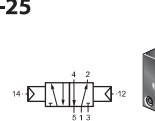

(*) **V52V2P014**

DOUBLE PNEUMATIC PILOT
DOPPIO COMANDO PNEUMATICO

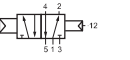

V52V2PD14

..... WITH DIFFERENTIAL
..... CON DIFFERENZIALE

pag. B-26

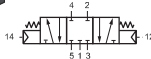
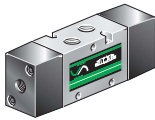

(*) **V53V2P614**

DOUBLE PNEUMATIC PILOT - CENTER POSITION CLOSED
DOPPIO COMANDO PNEUMATICO - CENTRI CHIUSI

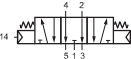

(*) **V53V2P914**

DOUBLE PNEUMATIC PILOT - CENTER POSITION OPEN
DOPPIO COMANDO PNEUMATICO - CENTRI APERTI

pag. B-26

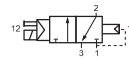
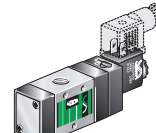

E32W1S614 -

SINGLE SOLENOID VALVE - INTERNAL PRESSURE RETURN
COMANDO ELETTROPNEUMATICO - MOLLA PNEUMATICA

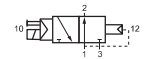
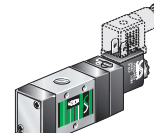

E32W1S914 -

SINGLE SOLENOID VALVE - INTERNAL PRESSURE RETURN
COMANDO ELETTROPNEUMATICO - MOLLA PNEUMATICA

pag. B-27

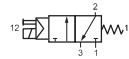
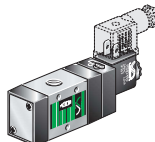

(*) **E32W1S6M4 -**

SINGLE SOLENOID VALVE - SPRING RETURN
COMANDO ELETTROPNEUMATICO - MOLLA MECCANICA

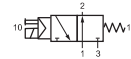
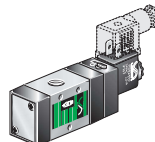

(*) **E32W1S9M4 -**

SINGLE SOLENOID VALVE - SPRING RETURN
COMANDO ELETTROPNEUMATICO - MOLLA MECCANICA

pag. B-27

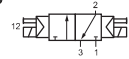
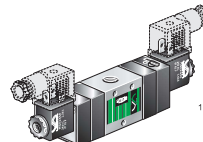

(*) **E32W2S014 -**

DOUBLE SOLENOID VALVE
DOPPIO COMANDO ELETTROPNEUMATICO

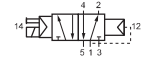
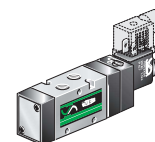

E52W1S014 -

SINGLE SOLENOID VALVE - INTERNAL PRESSURE RETURN
COMANDO ELETTROPNEUMATICO - MOLLA PNEUMATICA

pag. B-28

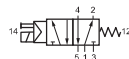
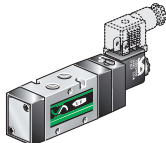

(*) **E52W1SM14 -**

SINGLE SOLENOID VALVE - SPRING RETURN
COMANDO ELETTROPNEUMATICO - MOLLA MECCANICA

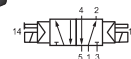
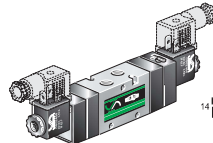

(*) **E52W2S014 -**

DOUBLE SOLENOID VALVE
DOPPIO COMANDO ELETTROPNEUMATICO

pag. B-28

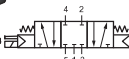
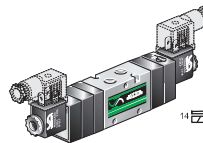

(*) **E53W2S614 -**

DOUBLE SOLENOID VALVE - CENTER POSITION CLOSED
DOPPIO COMANDO ELETTROPNEUMATICO - CENTRI CHIUSI

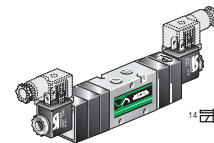

(*) **E53W2S914 -**

DOUBLE SOLENOID VALVE - CENTER POSITION OPEN
DOPPIO COMANDO ELETTROPNEUMATICO - CENTRI APERTI

pag. B-29

G1/4 COMPONENTS FOR ASSEMBLING AND SPARE PARTS / COMPONENTI PER L'ASSEMBLAGGIO E RICAMBI

(*) **ME .14**



PCH 014

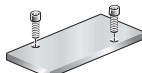

**SET1 1/4 SG
SET2 1/4 SG**

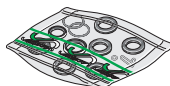

KM 014



pag. B-30

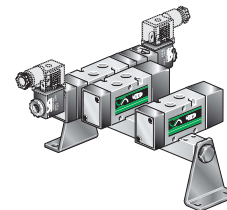

pag. B-33

**RTCOV.14
SBCOV.14
SACOV.14**

INDEX / INDICE

(*) ATEX versions see / Versioni ATEX vedi P. B-113

VALVES AND SOLENOID VALVES / VALVOLE ED ELETTROVALVOLA G1/2

pag. B-24

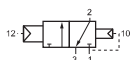

V32V1P612

SINGLE PNEUMATIC PILOT - INTERNAL PRESSURE RETURN
COMANDO PNEUMATICO - MOLLA PNEUMATICA

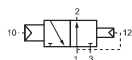

V32V1P912

SINGLE PNEUMATIC PILOT - INTERNAL PRESSURE RETURN
COMANDO PNEUMATICO - MOLLA PNEUMATICA

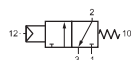

(*) **V32V1P6M2**

SINGLE PNEUMATIC PILOT - SPRING RETURN
COMANDO PNEUMATICO - MOLLA MECCANICA

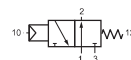

(*) **V32V1P9M2**

SINGLE PNEUMATIC PILOT - SPRING RETURN
COMANDO PNEUMATICO - MOLLA MECCANICA

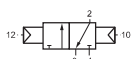

(*) **V32V2P012**

DOUBLE PNEUMATIC PILOT
DOPPIO COMANDO PNEUMATICO

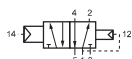

V52V1P012

SINGLE PNEUMATIC PILOT - INTERNAL PRESSURE RETURN
COMANDO PNEUMATICO - MOLLA PNEUMATICA

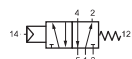

(*) **V52V1PM12**

SINGLE PNEUMATIC PILOT - SPRING RETURN
COMANDO PNEUMATICO - MOLLA MECCANICA

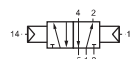

(*) **V52V2P012**

DOUBLE PNEUMATIC PILOT
DOPPIO COMANDO PNEUMATICO

pag. B-25

pag. B-26

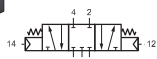

(*) **V53V2P612**

DOUBLE PNEUMATIC PILOT - CENTER POSITION CLOSED
DOPPIO COMANDO PNEUMATICO - CENTRI CHIUSI



(*) **V53V2P912**

DOUBLE PNEUMATIC PILOT - CENTER POSITION OPEN
DOPPIO COMANDO PNEUMATICO - CENTRI APERTI

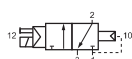

E32W1S612 -.....

SINGLE SOLENOID VALVE - INTERNAL PRESSURE RETURN
COMANDO ELETTROPNEUMATICO - MOLLA PNEUMATICA

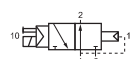

E32W1S912 -.....

SINGLE SOLENOID VALVE - INTERNAL PRESSURE RETURN
COMANDO ELETTROPNEUMATICO - MOLLA PNEUMATICA

pag. B-26

pag. B-27

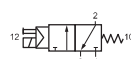

(*) **E32W1S6M2 -.....**

SINGLE SOLENOID VALVE - SPRING RETURN
COMANDO ELETTROPNEUMATICO - MOLLA MECCANICA

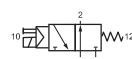

(*) **E32W1S9M2 -.....**

SINGLE SOLENOID VALVE - SPRING RETURN
COMANDO ELETTROPNEUMATICO - MOLLA MECCANICA

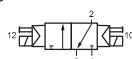

(*) **E32W2S012 -.....**

DOUBLE SOLENOID VALVE
DOPPIO COMANDO ELETTROPNEUMATICO



E32W1S012 -.....

SINGLE SOLENOID VALVE - INTERNAL PRESSURE RETURN
COMANDO ELETTROPNEUMATICO - MOLLA PNEUMATICA

pag. B-27

pag. B-28



(*) **E52W1SM12 -.....**

SINGLE SOLENOID VALVE - SPRING RETURN
COMANDO ELETTROPNEUMATICO - MOLLA MECCANICA

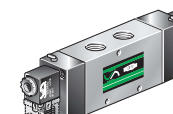

(*) **E52W2S012 -.....**

DOUBLE SOLENOID VALVE
DOPPIO COMANDO ELETTROPNEUMATICO

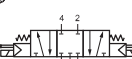
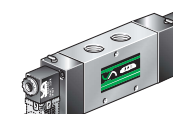

(*) **E53W2S612 -.....**

DOUBLE SOLENOID VALVE - CENTER POSITION CLOSED
DOPPIO COMANDO ELETTROPNEUMATICO - CENTRI CHIUSI

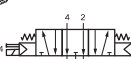
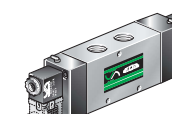

(*) **E53W2S912 -.....**

DOUBLE SOLENOID VALVE - CENTER POSITION OPEN
DOPPIO COMANDO ELETTROPNEUMATICO - CENTRI APERTI

pag. B-28

pag. B-29

(*) ATEX versions see / Versioni ATEX vedi P. B-113

DIRECT ACTING SOLENOID VALVES AND SPARE PARTS / ELETTROVALVOLE A COMANDO DIRETTO E RICAMBI

pag. B-35

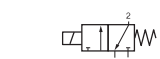

(*) **BE 1 -..... NC**

BE 1 -..... NO
(Coil: 5W) - (Solenoid: 5W)

DIRECT ACTING SOLENOID VALVE
ELETTROVALVOLA A COMANDO DIRETTO

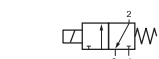

(*) **BE -..... NC**

BE -..... NO
(Coil: 5W) - (Solenoid: 5W)

DIRECT ACTING SOLENOID VALVES - MANIFOLD
ELETTROVALVOLE A COMANDO DIRETTO IN BATTERIA

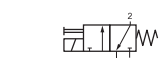

(*) **BE 1M -..... NC**

BE 1M -..... NO
(Coil: 5W) - (Solenoid: 5W)

DIRECT ACTING SOLENOID VALVE WITH MANUAL CONTROL
ELETTROVALVOLA A COMANDO DIRETTO CON CONTROLLO MANUALE



(*) **BE .M -..... NC**

BE .M -..... NO
(Coil: 5W) - (Solenoid: 5W)

DIRECT ACTING SOLENOID VALVES WITH MANUAL CONTROL - MANIFOLDS
ELETTROVALVOLE A COMANDO DIRETTO CON CONTROLLO MANUALE IN BATTERIA

PL-BE

KM-BE



pag. B-34

GE 1

GE

MBE-4-.....

pag. B-35

MBE-8NC-.....

MBE-8NO-.....

MS

CEP-1

SET1 1/2 SG
SET2 1/2 SG

pag. B-36



DIRECT ACTING SOLENOID VALVES 3/2 TUBE Ø4mm - MANIFOLD
ELETTROVALVOLE A COMANDO DIRETTO 3/2 TUBO Ø4mm IN BATTERIA

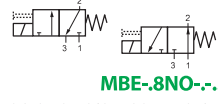

DIRECT ACTING SOLENOID VALVES 3/2 G1/8 - MANIFOLD
ELETTROVALVOLE A COMANDO DIRETTO 3/2 G1/8 IN BATTERIA





BUILDING FEATURES / CARATTERISTICHE COSTRUTTIVE

VESTA valves and solenoid valves with **G1/8, G1/4** and **G1/2** ports are available in the 3/2, 5/2 and 5/3 versions, with different forms of control (i.e. solenoid / pilot etc). The choice of high quality materials and technical solutions allows the valves to reach good performances even in harsh environmental conditions.

The spool is made in light aluminium alloy nickel treated by Niploy Process (see fig. **A**).

Its shape grants high nominal flow rates (see fig. **D**). Self lubricating lip seals (see fig. **B**) reduce internal friction (see fig. **C**) and provide the valve with a long lasting durable life.

Valves and Solenoid valves with connections **G1/8; G1/4** and **G1/2** ports can operate continuously without lubrication (see fig. **E**).

*Le valvole ed elettrovalvole VESTA con connessioni **G1/8; G1/4** e **G1/2** sono disponibili nelle versioni 3/2, 5/2 e 5/3 con più sistemi di attuazione e riposizionamento. Le soluzioni tecniche adottate ed i materiali impiegati hanno permesso di realizzare un prodotto che presenta elevate prestazioni funzionali anche in condizioni di impiego particolarmente gravose.*

*La spola, costruita in lega leggera e progettata per consentire elevate portate nominali (**D**), viene trattata superficialmente al nickel (Niploy Process) (**A**) onde acquisire una durezza maggiore ed una più elevata resistenza agli agenti aggressivi.*

*La combinazione tra la spola e le guarnizioni in elastomero nitrilico con profilo del labbro antiusura (**B**), permette, accanto ad una riduzione degli attriti, un'alta velocità di scambio e cicli di lavoro elevati (**C**), garantendo una maggiore durata della meccanica interna.*

*Tutti i modelli di valvole con connessioni **G1/8; G1/4** e **G1/2** possono essere utilizzati anche in assenza di lubrificazione (**E**).*

*L'ermeticità di funzionamento verso l'ambiente di lavoro ne fa inoltre un prodotto adatto all'impiego in settori cosiddetti "difficili" (**F**).*

Nelle pagine che seguono tutte le caratteristiche funzionali di ciascuna valvola sono convalidate dal Dipartimento di Meccanica del Politecnico di Torino.

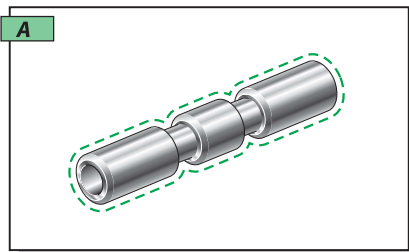

Light alloy spool with Niploy Process treated surface.
Spola in lega leggera con trattamento superficiale Niploy Process.

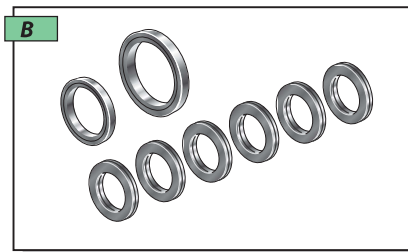

Self lubricating lip rubber seals.
Guarnizioni in elastomero nitrilico con profilo del labbro antiusura.

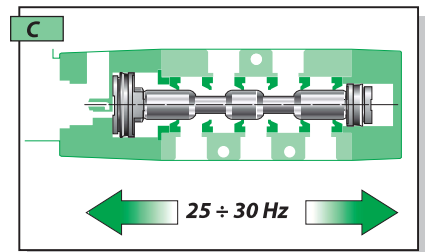

High working frequency.
Alta velocità di scambio per cicli di lavoro elevati.

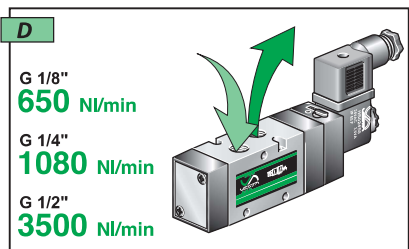

High nominal air flow.
Alta portata nominale.

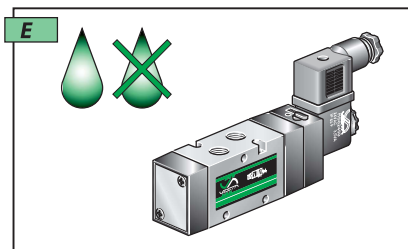

Possibility of operating continuously without lubrication.
Possibilità di funzionamento continuo privo di lubrificazione.

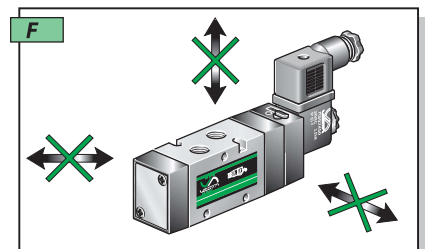

Protected against working environment (no spring return versions).
Protezione di funzionamento verso l'ambiente di lavoro (non nelle versioni con ritorno a molla).

WORKING PRINCIPLE / PRINCIPIO DI FUNZIONAMENTO

In the example here below, when the 5/2 valve **E52W1S018 - 02450** stands in the normal position, ports **4 - 5** and **1 - 2** are connected and the position is kept thanks to the pressure assured to the smallest piston (right side of the valve). When the valve is actuated, the same pressure is fed to the biggest piston. Its bigger surface create a force which allows to the spool to move and therefore to connect ports **4 - 1** and **2 - 3**.

In the mechanical spring version, the valve is kept in the normal position by a mechanical spring.

In the bistable versions, the position of the valve remains in its last switched state.

*Il principio di funzionamento del distributore 5/2 (nell'esempio la valvola a comando elettropneumatico e riposizionamento a molla pneumatica **E52W1S018 - 02450**) consiste nel mantenere costantemente in pressione il pistone di riposizionamento (fig. 1), utilizzando la fonte d'aria compressa presente nel condotto di alimentazione **1**, collegando le vie **1 - 2** e **4 - 5**.*

*L'eccitazione del solenoide mette in comunicazione il condotto in pressione **1** con la camera dove è alloggiato il pistone di comando.*

*Quest'ultimo, avendo un'area di spinta maggiore del pistone di riposizionamento, sposta la spola in modo tale da collegare i canali **1 - 4** e **2 - 3** (fig. 2).*

Diseccitando il solenoide si ripristina la posizione iniziale.

Nei sistemi bistabili (doppio comando elettropneumatico o doppio comando pneumatico) in assenza di segnale rimangono i collegamenti dell'ultimo azionamento.

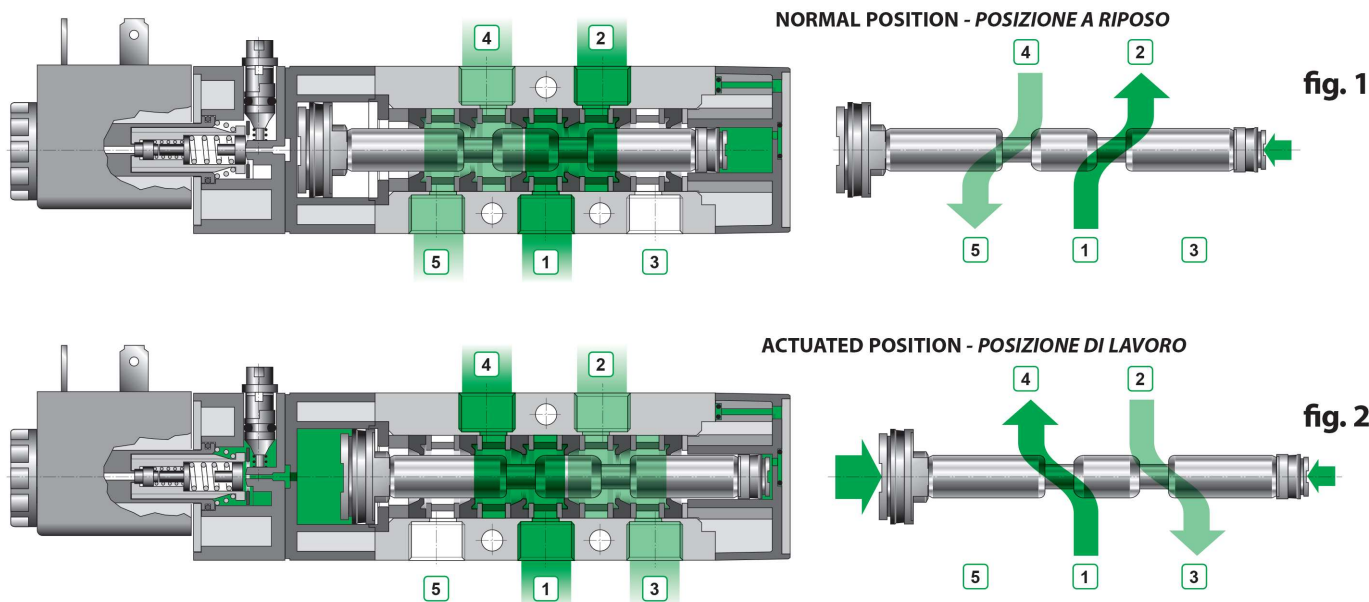

MANUAL OVERRIDING / AZIONAMENTO COMANDO MANUALE

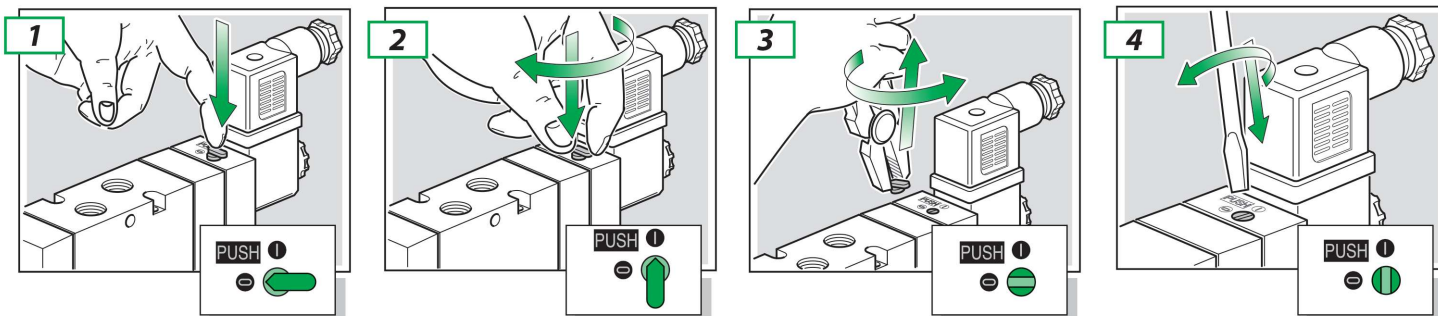

Push to actuated valve without locking. **Release the button to get back to normal position.**

*Per azionare la valvola, durante la fase di collaudo con pressione in linea senza collegamento elettrico, premere la leva del comando manuale. **Rilasciare per ripristinare la condizione di riposo.***

To actuate the valve permanently push the M/O (manual override) and rotate clockwise 90°. **To return to normal position, push the M/O again and turn 90° anticlockwise.**

*Per azionare la valvola in modo permanente premere la leva del comando manuale e ruotare in senso orario sino alla posizione 1. **Ruotare in senso antiorario per ripristinare la condizione di riposo.***

If the M/O is no longer required, then turn the M/O anticlockwise until it breaks off.

Terminato il collaudo ruotare in senso antiorario la leva sino alla rottura.

If the M/O is required after breaking off a screwdriver can be used.

Per interventi successivi sul comando manuale usare un adeguato cacciavite ed operare come al punto 1 o 2.



SERIE **G1/8, G1/4, G1/2**

**VALVES AND SOLENOID VALVES "E" SERIES
VALVOLE ED ELETTROVALVOLE SERIE "E"**

COMMON FEATURES VALVES G1/8 SERIES / CARATTERISTICHE COMUNI VALVOLE SERIE G1/8

G1/8	Port connections	G1/8	Connessioni di lavoro	G1/8
	Pilot connections	G1/8	Connessioni operatori	G1/8
	Flow section	Ø 6 mm	Diametro nominale	Ø 6 mm
	Environment temperature range	-10 °C ÷ +50 °C	Temperatura ambiente	-10 °C ÷ +50 °C
	Temperature range of medium	0 °C ÷ +40 °C	Temperatura fluido	0 °C ÷ +40 °C
	Lubrication	Not required	Lubrificazione	Non necessaria
	Medium	Filtered air	Fluido	Aria filtrata
	Reference temperature	+20 °C	Temperatura nominale	+20 °C
	Reference pressure	6 bar	Pressione nominale	6 bar
	3/2 VALVES AND SOLENOID VALVES		VALVOLE ED ELETTROVALVOLE 3/2	
Fixing	n°3 holes Ø 4,25 manifold system see p. 30.	Fissaggio	n°3 fori laterali Ø 4,25 su collettore vedi p. 32	
Nominal air flow	650 NI/min	Portata nominale	650 NI/min	
Fluid conductance "C"	2,7 NI/s bar	Valore conduttanza "C"	2,7 NI/s bar	
Critical pressure ratio "b"	0,203	Rapporto critico delle pressioni "b"	0,203	
5/2 VALVES AND SOLENOID VALVES		VALVOLE ED ELETTROVALVOLE 5/2		
Fixing	n°3 holes Ø 4,25 manifold system pp. 30 ÷ 32.	Fissaggio	n°3 fori laterali Ø 4,25 su collettore vedi p. 32	
Nominal air flow	650 NI/min	Portata nominale	650 NI/min	
Fluid conductance "C"	2,7 NI/s bar	Valore conduttanza "C"	2,7 NI/s bar	
Critical pressure ratio "b"	0,203	Rapporto critico delle pressioni "b"	0,203	
5/3 VALVES AND SOLENOID VALVES		VALVOLE ED ELETTROVALVOLE 5/3		
Fixing	n°3 holes Ø 4,25 manifold system pp. 30 ÷ 32.	Fissaggio	n°3 fori laterali Ø 4,25 su collettore vedi p. 32	
Nominal air flow	530 NI/min	Portata nominale	530 NI/min	
Fluid conductance "C"	2,17 NI/s bar	Valore conduttanza "C"	2,17 NI/s bar	
Critical pressure ratio "b"	0,236	Rapporto critico delle pressioni "b"	0,236	

VALVES AND SOLENOID VALVES G1/4 SERIES / VALVOLE ED ELETTROVALVOLE SERIE G1/4

G1/4	Port connections	G1/4	Connessioni di lavoro	G1/4
	Pilot connections	G1/8	Connessioni operatori	G 1/8
	Flow section	Ø 8 mm	Diametro nominale	Ø 8 mm
	Environment temperature range	-10 °C ÷ +50 °C	Temperatura ambiente	-10 °C ÷ +50 °C
	Temperature range of medium	0 °C ÷ +40 °C	Temperatura fluido	0 °C ÷ +40 °C
	Lubrication	Not required	Lubrificazione	Non necessaria
	Medium	Filtered air	Fluido	Aria filtrata
	Reference temperature	+20 °C	Temperatura nominale	+20 °C
	Reference pressure	6 bar	Pressione nominale	6 bar
	3/2 VALVES AND SOLENOID VALVES		VALVOLE ED ELETTROVALVOLE 3/2	
Fixing	n°3 holes Ø 4,25 manifold system see p. 33.	Fissaggio	n°3 fori laterali Ø 4,25 su collettore vedi p. 33	
Nominal air flow	1080 NI/min	Portata nominale	1080 NI/min	
Fluid conductance "C"	4,34 NI/s bar	Valore conduttanza "C"	4,34 NI/s bar	
Critical pressure ratio "b"	0,212	Rapporto critico delle pressioni "b"	0,212	
5/2 VALVES AND SOLENOID VALVES		VALVOLE ED ELETTROVALVOLE 5/2		
Fixing	n°3 holes Ø 4,25 manifold system pp. 30 ÷ 31, 33.	Fissaggio	n°3 fori laterali Ø 4,25 su collettore vedi p. 33	
Nominal air flow	1080 NI/min	Portata nominale	1080 NI/min	
Fluid conductance "C"	4,34 NI/s bar	Valore conduttanza "C"	4,34 NI/s bar	
Critical pressure ratio "b"	0,212	Rapporto critico delle pressioni "b"	0,212	
5/3 VALVES AND SOLENOID VALVES		VALVOLE ED ELETTROVALVOLE 5/3		
Fixing	n°3 holes Ø 4,25 manifold system pp. 30 ÷ 31, 33.	Fissaggio	n°3 fori laterali Ø 4,25 su collettore vedi p. 33	
Nominal air flow	800 NI/min	Portata nominale	800 NI/min	
Fluid conductance "C"	3,22 NI/s bar	Valore conduttanza "C"	3,22 NI/s bar	
Critical pressure ratio "b"	0,265	Rapporto critico delle pressioni "b"	0,265	

VALVES AND SOLENOID VALVES G1/2 SERIES / VALVOLE ED ELETTROVALVOLE SERIE G1/2

G1/2	Port connections	G1/2	Connessioni di lavoro	G1/2
	Pilot connections	G1/8	Connessioni operatori	G 1/8
	Flow section	Ø 15 mm	Diametro nominale	Ø 15 mm
	Environment temperature range	-10 °C ÷ +50 °C	Temperatura ambiente	-10 °C ÷ +50 °C
	Temperature range of medium	0 °C ÷ +40 °C	Temperatura fluido	0 °C ÷ +40 °C
	Lubrication	Not required	Lubrificazione	Non necessaria
	Medium	Filtered air	Fluido	Aria filtrata
	Reference temperature	+20 °C	Temperatura nominale	+20 °C
	Reference pressure	6 bar	Pressione nominale	6 bar
	3/2 VALVES AND SOLENOID VALVES		VALVOLE ED ELETTROVALVOLE 3/2	
Fixing	n°3 holes Ø 5,5	Fissaggio	n°3 fori laterali Ø 5,5	
Nominal air flow	3500 NI/min	Portata nominale	3500 NI/min	
Fluid conductance "C"	12,88 NI/s bar	Valore conduttanza "C"	12,88 NI/s bar	
Critical pressure ratio "b"	0,393	Rapporto critico delle pressioni "b"	0,393	
5/2 VALVES AND SOLENOID VALVES		VALVOLE ED ELETTROVALVOLE 5/2		
Fixing	n°3 holes Ø 5,5	Fissaggio	n°3 fori laterali Ø 5,5	
Nominal air flow	3500 NI/min	Portata nominale	3500 NI/min	
Fluid conductance "C"	12,88 NI/s bar	Valore conduttanza "C"	12,88 NI/s bar	
Critical pressure ratio "b"	0,396	Rapporto critico delle pressioni "b"	0,396	
5/3 VALVES AND SOLENOID VALVES		VALVOLE ED ELETTROVALVOLE 5/3		
Fixing	n°3 holes Ø 5,5	Fissaggio	n°3 fori laterali Ø 5,5	
Nominal air flow	3000 NI/min	Portata nominale	3000 NI/min	
Fluid conductance "C"	10,76 NI/s bar	Valore conduttanza "C"	3,22 NI/s bar	
Critical pressure ratio "b"	0,42	Rapporto critico delle pressioni "b"	0,265	

PNEUMATIC VALVES FEATURES / CARATTERISTICHE VALVOLE PNEUMATICHE

Size Taglia	Code Codice	Nominal pilot pressure (bar) Pressione di pilotaggio nominale (bar)		Nominal max frequency (Hz) Frequenza max nominale (Hz)		Operating pressure range (bar) Pressione di esercizio (bar)	
G 1/8"	V32V1P618	4,5 bar (10 bar)		31 Hz		2,2 ÷ 10 bar	
	V32V1P918	4,5 bar (10 bar)		31 Hz		2,2 ÷ 10 bar	
	V32V1P6M8	2,7 bar		13 Hz		1,5 ÷ 10 bar	
	V32V1P9M8	2,7 bar		13 Hz		1,5 ÷ 10 bar	
	V32V2P018	1,3 bar		43 Hz		1,2 ÷ 10 bar	
	V52V1P018	4,5 bar (10 bar)		30 Hz		2,5 ÷ 10 bar	
	V52V1PM18	2,7 bar		13 Hz		1,5 ÷ 10 bar	
	V52V2P018	1,3 bar		42 Hz		1,5 ÷ 10 bar	
	V52V2PD18	1,3 bar		42 Hz		1,5 ÷ 10 bar	
	V53V2P618	3,2 bar		9 Hz		1,5 ÷ 10 bar	
	V53V2P918	3,2 bar		9 Hz		1,5 ÷ 10 bar	
G 1/4"	V32V1P614	4 bar (10 bar)		22 Hz		2,2 ÷ 10 bar	
	V32V1P914	4 bar (10 bar)		22 Hz		2,2 ÷ 10 bar	
	V32V1P6M4	2,85 bar		11 Hz		1,5 ÷ 10 bar	
	V32V1P9M4	2,85 bar		11 Hz		1,5 ÷ 10 bar	
	V32V2P014	1,3 bar		31 Hz		1,2 ÷ 10 bar	
	V52V1P014	4 bar (10 bar)		21 Hz		2,5 ÷ 10 bar	
	V52V1PM14	2,85 bar		10 Hz		1,5 ÷ 10 bar	
	V52V2P014	1,3 bar		30 Hz		1,5 ÷ 10 bar	
	V52V2PD14	1,3 bar		30 Hz		1,5 ÷ 10 bar	
	V53V2P614	3,6 bar		8 Hz		1,5 ÷ 10 bar	
	V53V2P914	3,6 bar		8 Hz		1,5 ÷ 10 bar	
G 1/2"	V32V1P612	4 bar (10 bar)		12 Hz		2,2 ÷ 10 bar	
	V32V1P912	4 bar (10 bar)		12 Hz		2,2 ÷ 10 bar	
	V32V1P6M2	2,85 bar		8 Hz		1,5 ÷ 10 bar	
	V32V1P9M2	2,85 bar		8 Hz		1,5 ÷ 10 bar	
	V32V2P012	1,3 bar		14 Hz		1,2 ÷ 10 bar	
	V52V1P012	4 bar (10 bar)		12 Hz		2,5 ÷ 10 bar	
	V52V1PM12	2,85 bar		7 Hz		1,5 ÷ 10 bar	
	V52V2P012	1,3 bar		13 Hz		1,5 ÷ 10 bar	
	V53V2P612	3,2 bar		6 Hz		1,5 ÷ 10 bar	
	V53V2P912	3,2 bar		6 Hz		1,5 ÷ 10 bar	

SOLENOID VALVES FEATURES / CARATTERISTICHE ELETTROVALVOLE

Size Taglia	Code Codice	Average actining response (ms) Tempo medio di risposta in eccitazione (ms)		Average disactining response (ms) Tempo medio di risposta in diseccitazione (ms)		Nominal max frequency (Hz) Frequenza max nominale (Hz)		Operating pressure range (bar) Pressione di esercizio (bar)	
		AC	DC	AC	DC	AC	DC	AC	DC
G 1/8"	E32W1S618	17 ms	19 ms	20 ms	24 ms	29 Hz	18 Hz	2,2 ÷ 10 bar	
	E32W1S918	17 ms	19 ms	20 ms	24 ms	29 Hz	18 Hz	2,2 ÷ 10 bar	
	E32W1S6M8	17 ms	19 ms	21 ms	34 ms	13 Hz	13 Hz	3,2 ÷ 10 bar	
	E32W1S9M8	17 ms	19 ms	21 ms	34 ms	13 Hz	13 Hz	3,2 ÷ 10 bar	
	E32W2S018	10 ms	12 ms	10 ms	12 ms	31 Hz	23 Hz	1,2 ÷ 10 bar	
	E52W1S018	10 ms	17 ms	20 ms	24 ms	29 Hz	17 Hz	2,5 ÷ 10 bar	
	E52W1SM18	17 ms	19 ms	21 ms	34 ms	13 Hz	13 Hz	3,2 ÷ 10 bar	
	E52W2S018	10,5 ms	12,5 ms	10,5 ms	12,5 ms	31 Hz	22 Hz	1,5 ÷ 10 bar	
	E53W2S618	16 ms	19 ms	16 ms	19 ms	9 Hz	9 Hz	3 ÷ 10 bar	
	E53W2S918	16 ms	19 ms	16 ms	19 ms	9 Hz	9 Hz	3 ÷ 10 bar	
G 1/4"	E32W1S614	18 ms	21 ms	33 ms	44 ms	17 Hz	14 Hz	2,2 ÷ 10 bar	
	E32W1S914	18 ms	21 ms	33 ms	44 ms	17 Hz	14 Hz	2,2 ÷ 10 bar	
	E32W1S6M4	19 ms	21 ms	35 ms	46 ms	11 Hz	11 Hz	2,5 ÷ 10 bar	
	E32W1S9M4	19 ms	21 ms	35 ms	46 ms	11 Hz	11 Hz	2,5 ÷ 10 bar	
	E32W2S014	11 ms	14 ms	11 ms	14 ms	27 Hz	22 Hz	1,2 ÷ 10 bar	
	E52W1S014	18 ms	21 ms	33 ms	44 ms	16 Hz	13 Hz	2,5 ÷ 10 bar	
	E52W1SM14	19 ms	21 ms	35 ms	46 ms	11 Hz	11 Hz	2,5 ÷ 10 bar	
	E52W2S014	11 ms	14 ms	11 ms	14 ms	27 Hz	21 Hz	1,5 ÷ 10 bar	
	E53W2S614	17 ms	20 ms	17 ms	20 ms	8 Hz	8 Hz	3 ÷ 10 bar	
	E53W2S914	17 ms	20 ms	17 ms	20 ms	8 Hz	8 Hz	3 ÷ 10 bar	
G 1/2"	E32W1S612	43 ms	45 ms	55 ms	55 ms	13 Hz	12 Hz	2,2 ÷ 10 bar	
	E32W1S912	43 ms	45 ms	55 ms	55 ms	13 Hz	12 Hz	2,2 ÷ 10 bar	
	E32W1S6M2	47 ms	49 ms	60 ms	60 ms	8 Hz	8 Hz	2,5 ÷ 10 bar	
	E32W1S9M2	47 ms	49 ms	60 ms	60 ms	8 Hz	8 Hz	2,5 ÷ 10 bar	
	E32W2S012	22 ms	26 ms	22 ms	26 ms	16 Hz	15 Hz	1,2 ÷ 10 bar	
	E52W1S012	47 ms	49 ms	58 ms	58 ms	11 Hz	10 Hz	2,5 ÷ 10 bar	
	E52W1SM12	47 ms	49 ms	60 ms	60 ms	8 Hz	8 Hz	2,5 ÷ 10 bar	
	E52W2S012	24 ms	28 ms	24 ms	28 ms	14 Hz	13 Hz	1,5 ÷ 10 bar	
	E53W2S612	49 ms	49 ms	60 ms	60 ms	6 Hz	6 Hz	3 ÷ 10 bar	
	E53W2S912	49 ms	49 ms	60 ms	60 ms	6 Hz	6 Hz	3 ÷ 10 bar	

For electrical features solenoid pilot see pp. B-35 and B-37.
Caratteristiche elettriche elettrovalvole per solenoide vedi pp. B-35 e B-37.



V32V1P . 1.

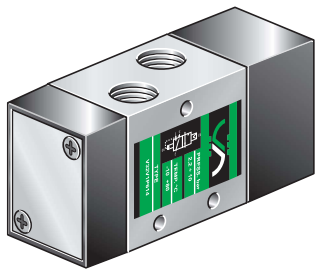

VALVE / VALVOLA 3/2 SINGLE PNEUMATIC PILOT - INTERNAL PRESSURE RETURN COMANDO PNEUMATICO - RIPOSIZIONAMENTO A MOLLA PNEUMATICA

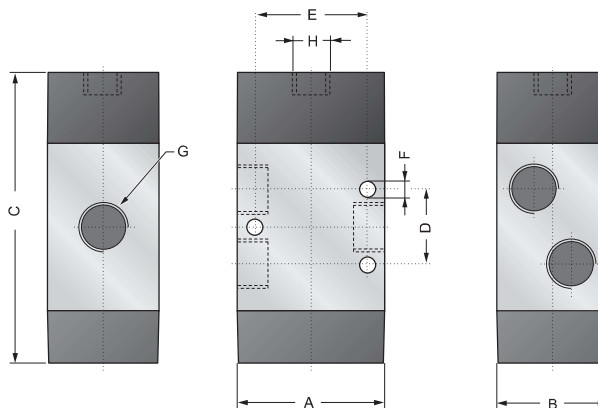

SIMBOLS / SIMBOLI

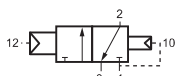

V32V1P61.

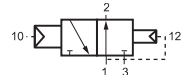

V32V1P91.

DIAGRAMS / DIAGRAMMI

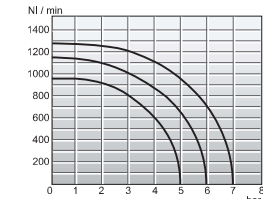
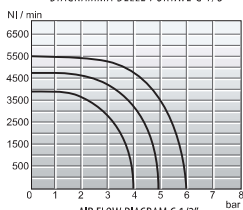
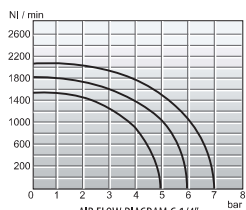
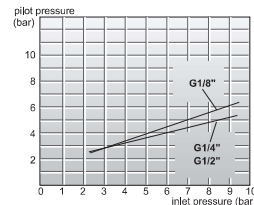
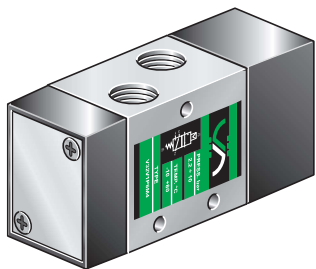

DIAGRAM / DIAGRAMMA



Size Taglia	A	B	C	D	E	ØF	G	H
G1/8	30	26	74	18	23	4,25	G1/8	G1/8
G1/4	40	30	81,5	20	30	4,25	G1/4	G1/8
G1/2	60	40	127	40	50	5,5	G1/2	G1/8

V32V1P . M.



VALVE / VALVOLA 3/2 SINGLE PNEUMATIC PILOT - SPRING RETURN COMANDO PNEUMATICO - RIPOSIZIONAMENTO A MOLLA MECCANICA

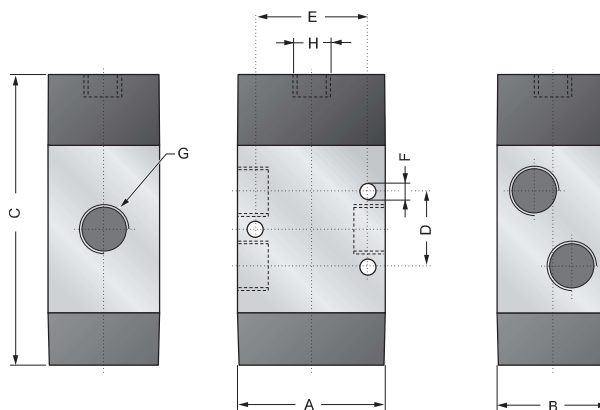

SIMBOLS / SIMBOLI

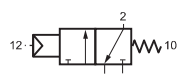

V32V1P6M.

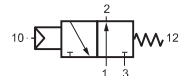

V32V1P9M.

DIAGRAMS / DIAGRAMMI

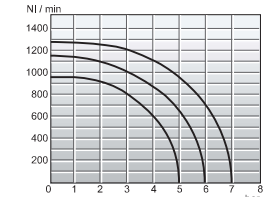
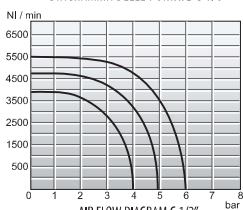
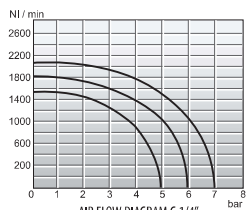
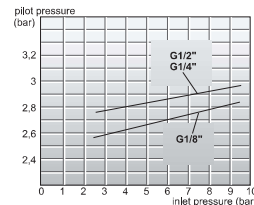

DIAGRAM / DIAGRAMMA



(*) ATEX versions see / Versioni ATEX vedi P. B-113

Size Taglia	A	B	C	D	E	ØF	G	H
G1/8	30	26	74	18	23	4,25	G1/8	G1/8
(*) G1/4	40	30	81,5	20	30	4,25	G1/4	G1/8
(*) G1/2	60	40	118	40	50	5,5	G1/2	G1/8

VALVE / VALVOLA 3/2

DOUBLE PNEUMATIC PILOT / *DOPIO COMANDO PNEUMATICO*

V32V2P01.

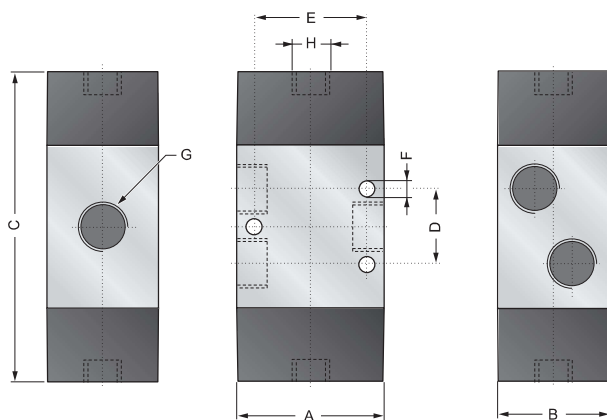

DIAGRAMS / DIAGRAMMI

SIMBOL / SIMBOLO

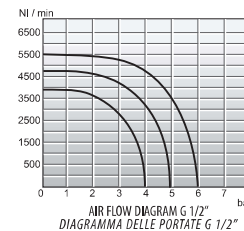
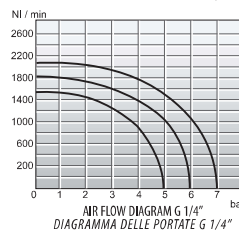
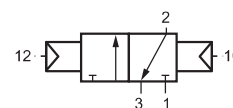
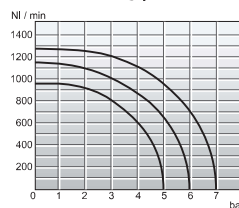
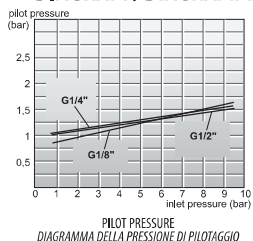

DIAGRAM / DIAGRAMMA



(*) ATEX versions see / *Versioni ATEX vedi P. B-113*

Size Taglia	A	B	C	D	E	ØF	G	H
G1/8	30	26	79	18	23	4,25	G1/8	G1/8
(*) G1/4	40	30	87	20	30	4,25	G1/4	G1/8
(*) G1/2	60	40	132	40	50	5,5	G1/2	G1/8

VALVE / VALVOLA 5/2

SINGLE PNEUMATIC PILOT / *COMANDO PNEUMATICO*

V52V1P.1.

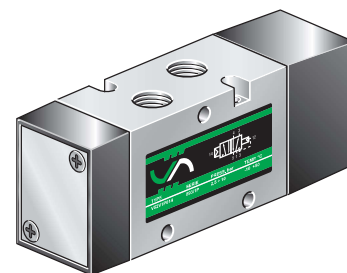
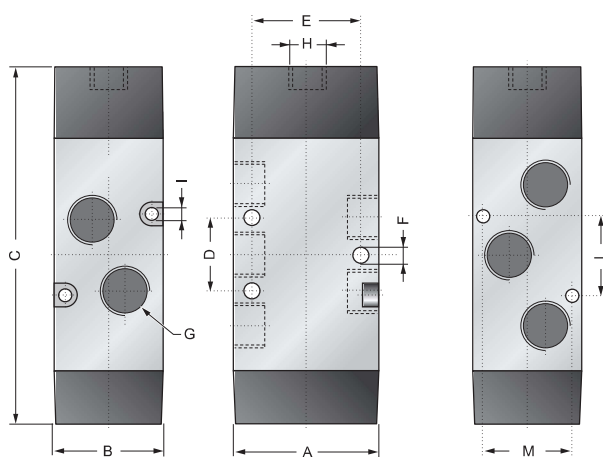

DIAGRAMS / DIAGRAMMI

SIMBOLS / SIMBOLI

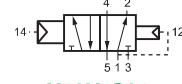
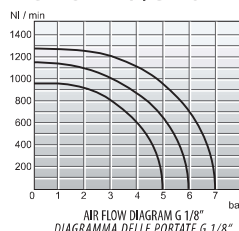

V52V1P01.

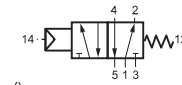

V52V1PM1.

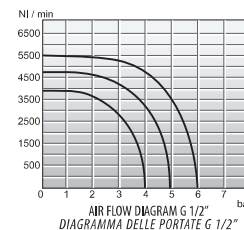
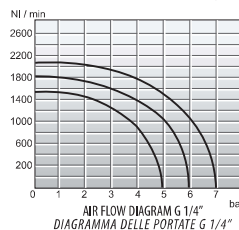
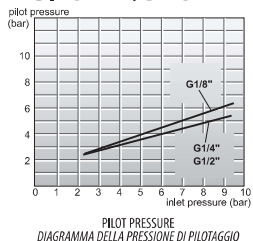

DIAGRAM / DIAGRAMMA



(*) ATEX versions see / *Versioni ATEX vedi P. B-113*

Size Taglia	A	B	C	D	E	ØF	G	H	ØI	L	M
1/8	30	26	91	18	23	4,25	G1/8	G1/8	3,25	28,6	20
(*) 1/4	40	30	100	20	30	4,25	G1/4	G1/8	3,25	21	24,6
(*) 1/2	60	40	167	40	50	5,5	G1/2	G1/8	—	—	—



V52V2P . 1.

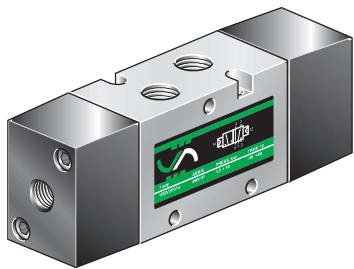

VALVE / VALVOLA 5/2 DOUBLE PNEUMATIC PILOT / DOPPIO COMANDO PNEUMATICO

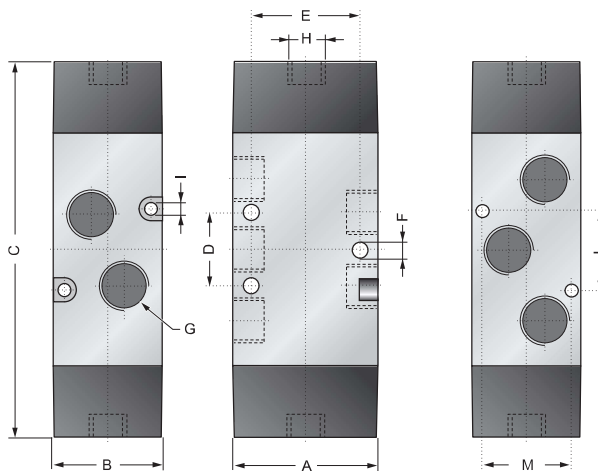

SIMBOLS / SIMBOLI



V52V2P01.



V52V2PD1.

DIAGRAMS / DIAGRAMMI

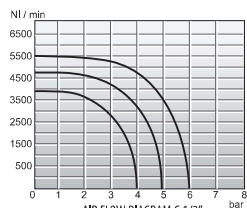
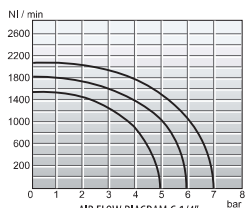
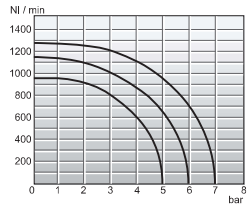
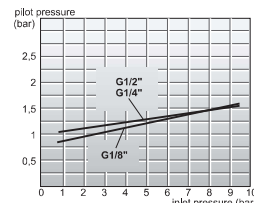

DIAGRAM / DIAGRAMMA



(*) ATEX versions see / Versioni ATEX vedi P. B-113

Size Taglia	A	B	C	D	E	ØF	G	H	ØI	L	M
1/8	30	26	96	18	23	4,25	G1/8	G1/8	3,25	28,6	20
(*) 1/4	40	30	105	20	30	4,25	G1/4	G1/8	3,25	21	24,6
(*) 1/2	60	40	172	40	50	5,5	G1/2	G1/8	—	—	—

V53V2P . 1.

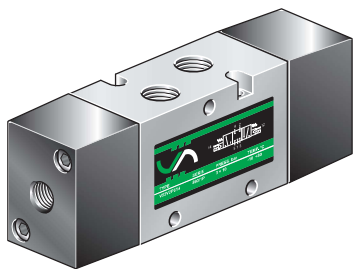

VALVE / VALVOLA 5/3 DOUBLE PNEUMATIC PILOT / DOPPIO COMANDO PNEUMATICO

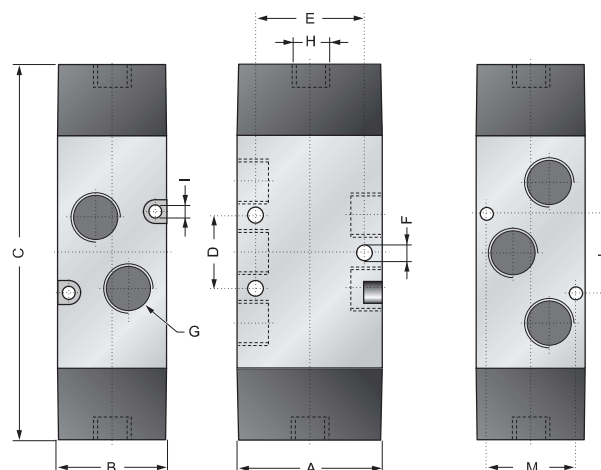

SIMBOLS / SIMBOLI



V53V2P61.



V53V2P91.

DIAGRAMS / DIAGRAMMI

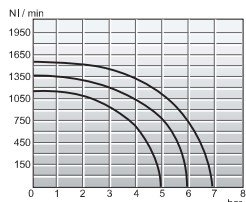
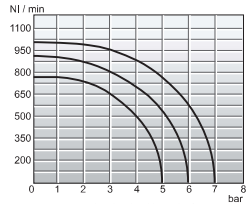
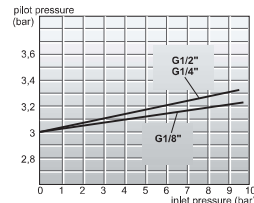

DIAGRAM / DIAGRAMMA



(*) versions see / Versioni vedi P. B-113

Size Taglia	A	B	C	D	E	ØF	G	H	ØI	L	M
1/8	30	26	108	18	23	4,25	G1/8	G1/8	3,25	28,6	20
1/4	40	30	105	20	30	4,25	G1/4	G1/8	3,25	21	24,6
1/2	60	40	192	40	50	5,5	G1/2	G1/8	—	—	—

SOLENOID VALVE / 3/2

SINGLE SOLENOID VALVE - INTERNAL PRESSURE RETURN
 COMANDO ELETTROPNEUMATICO - RIPOSIZIONAMENTO MOLLA PNEUMATICA

E32W1S . 1. -

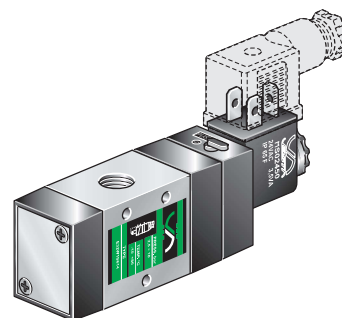
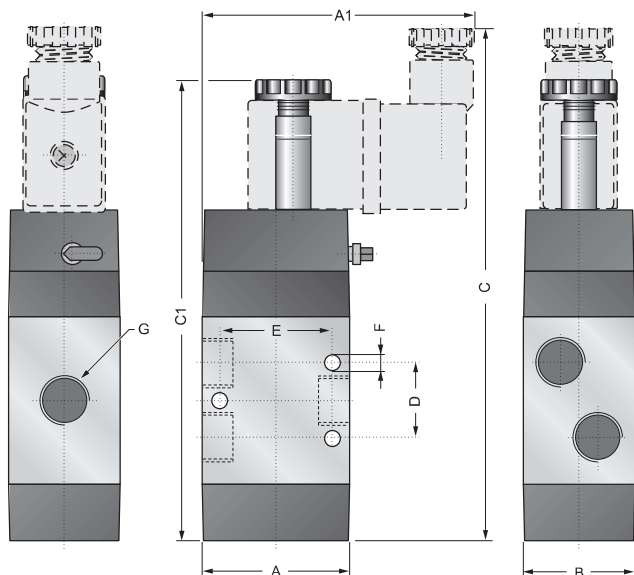

Size Taglia	A	A1	B	C	C1	D	E	ØF	G
1/8	30	63	26	133	119	18	23	4,25	G1/8
1/4	40	73	30	140	125	20	30	4,25	G1/4
1/2	60	60	40	181	167	40	50	5,5	G1/2

DIAGRAMS / DIAGRAMMI

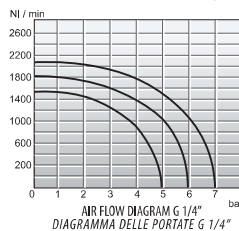
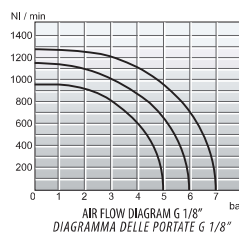

SIMBOLS / SIMBOLI

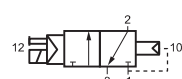

E32W1S61. -.....

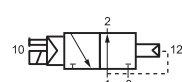

E32W1S91. -.....

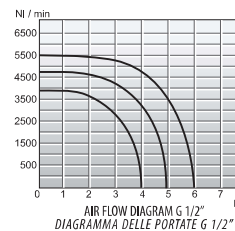

SOLENOID VALVE / ELETTROVALVOLA 3/2

SINGLE SOLENOID VALVE - SPRING RETURN
 COMANDO ELETTROPNEUMATICO - RIPOSIZIONAMENTO MOLLA MECCANICA

E32W1S . M. -

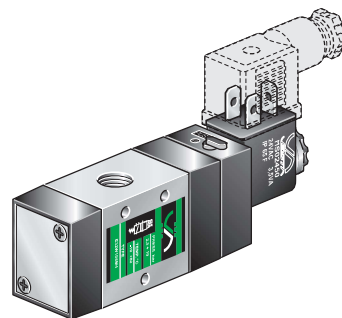
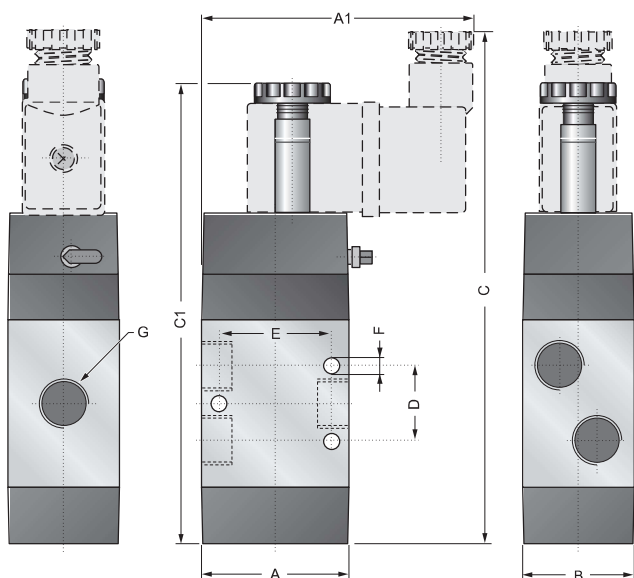

Size Taglia	A	A1	B	C	C1	D	E	ØF	G
1/8	30	63	26	133	119	18	23	4,25	G1/8
(*) 1/4	40	73	30	140	125	20	30	4,25	G1/4
(*) 1/2	60	60	40	172	158	40	50	5,5	G1/2

(*) ATEX versions see / Versioni ATEX vedi P.

DIAGRAMS / DIAGRAMMI

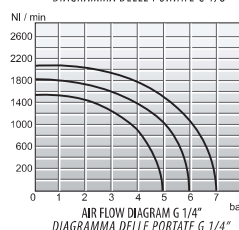
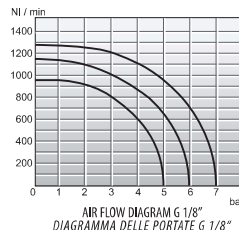

SIMBOLS / SIMBOLI

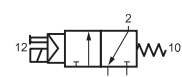

E32W1S6M -.....

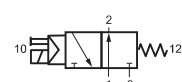

E32W1S9M -.....

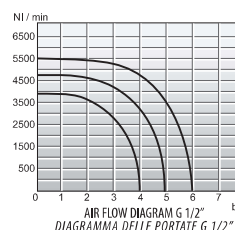



E32W2S01. -

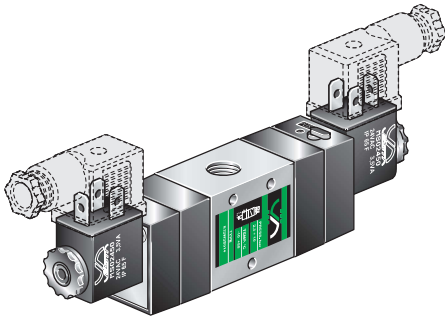

SIMBOL / SIMBOLO

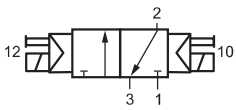

DIAGRAMS / DIAGRAMMI

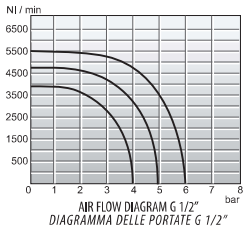
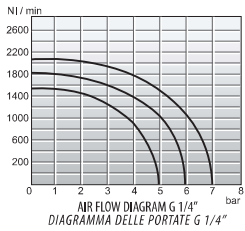
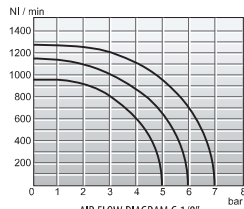

SOLENOID VALVE / 3/2

DOUBLE SOLENOID VALVE / DOPPIO COMANDO ELETTROPNEUMATICO

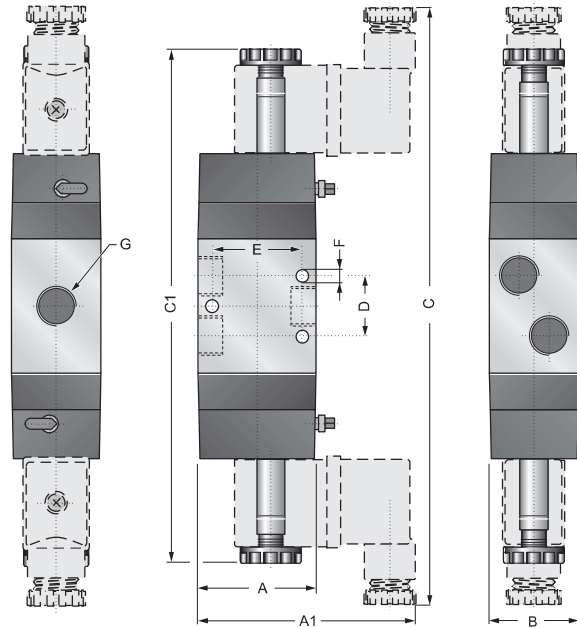

(*) ATEX versions see / Versioni ATEX vedi P. B-113

Size Taglia	A	A1	B	C	C1	D	E	ØF	G
1/8	30	63	26	197	169	18	23	4,25	G1/8
(*) 1/4	40	73	30	203	175	20	30	4,25	G1/4
(*) 1/2	60	60	40	240	212	40	50	5,5	G1/2

E52W1S.1. -

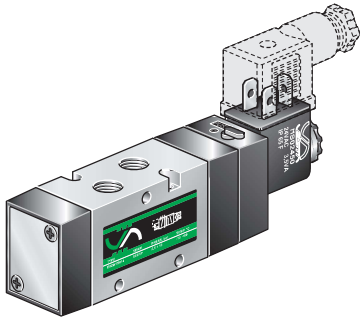

SIMBOLS / SIMBOLI

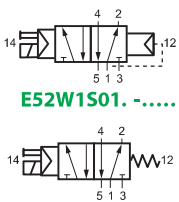

DIAGRAMS / DIAGRAMMI

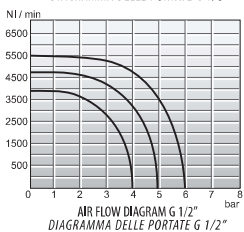
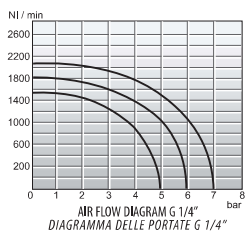
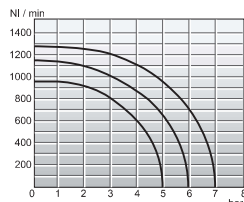

SOLENOID VALVE / 5/2

SINGLE SOLENOID VALVE / COMANDO ELETTROPNEUMATICO

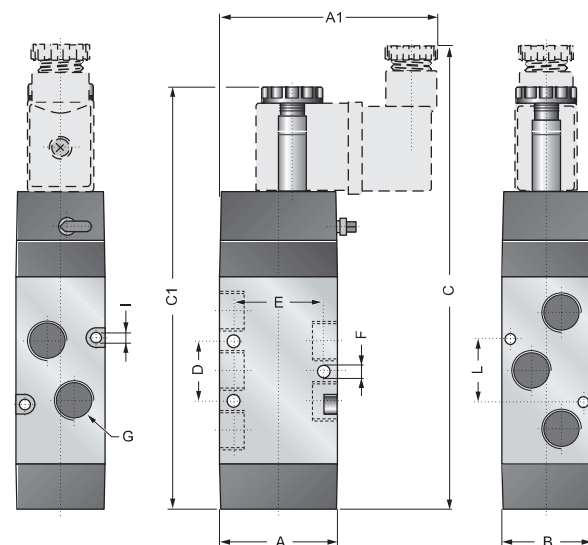

(*) ATEX versions see / Versioni ATEX vedi P. B-113

Size Taglia	A	A1	B	C	C1	D	E	ØF	G	ØI	L
1/8	30	63	26	150	136	18	23	4,25	G1/8	3,25	28,6
(*) 1/4	40	73	30	158	143	20	30	4,25	G1/4	3,25	21
(*) 1/2	60	60	40	221	207	40	50	5,5	G1/2	—	—

E52W2S01. -

SOLENOID VALVE / 5/2
DOUBLE SOLENOID VALVE / *DOPIO COMANDO ELETTROPNEUMATICO*

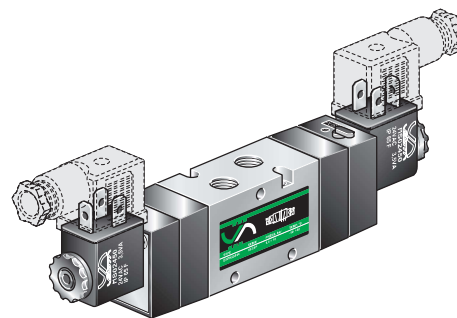
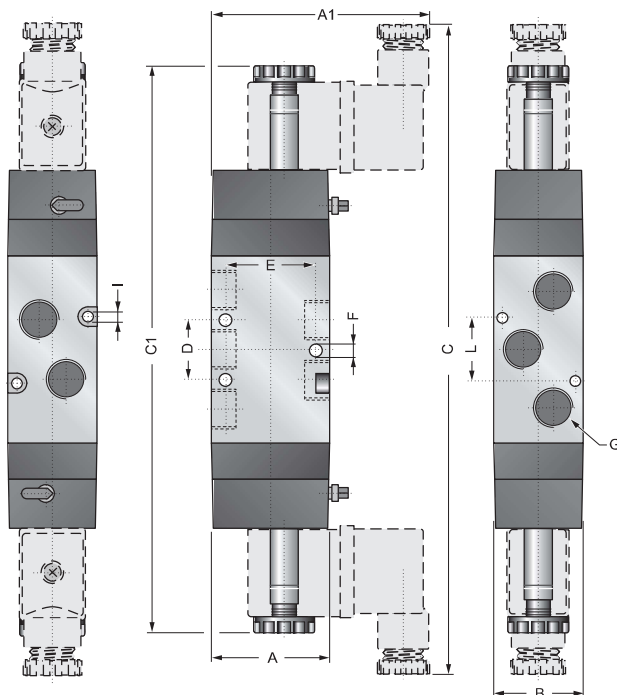

DIAGRAMS / DIAGRAMMI

SIMBOL / SIMBOLO

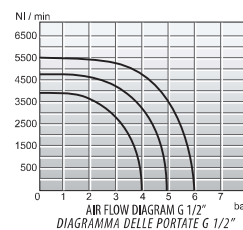
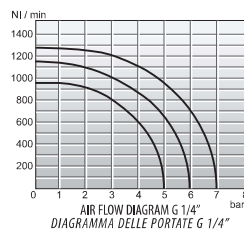
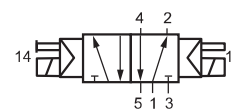
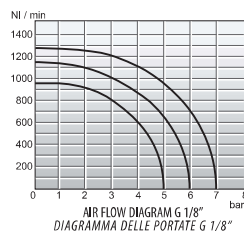

Size Taglia	A	A1	B	C	C1	D	E	ØF	G	ØI	L
1/8	30	63	26	215	186	18	23	4,25	G1/8	3,25	28,6
(*) 1/4	40	73	30	220	191	20	30	4,25	G1/4	3,25	21
(*) 1/2	60	60	40	280	252	40	50	5,5	G1/2	—	—

(*) ATEX versions see P. B-113
Versioni ATEX vedi P. B-113

SOLENOID VALVE / 5/3

DOUBLE SOLENOID VALVE / *DOPIO COMANDO ELETTROPNEUMATICO*

E53W2S. 1. -

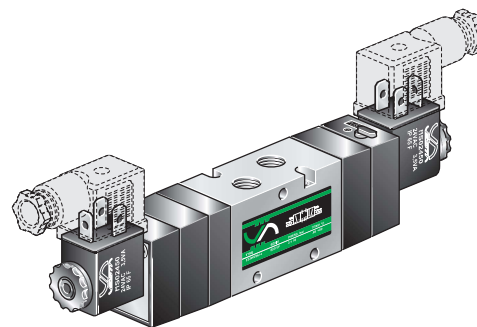
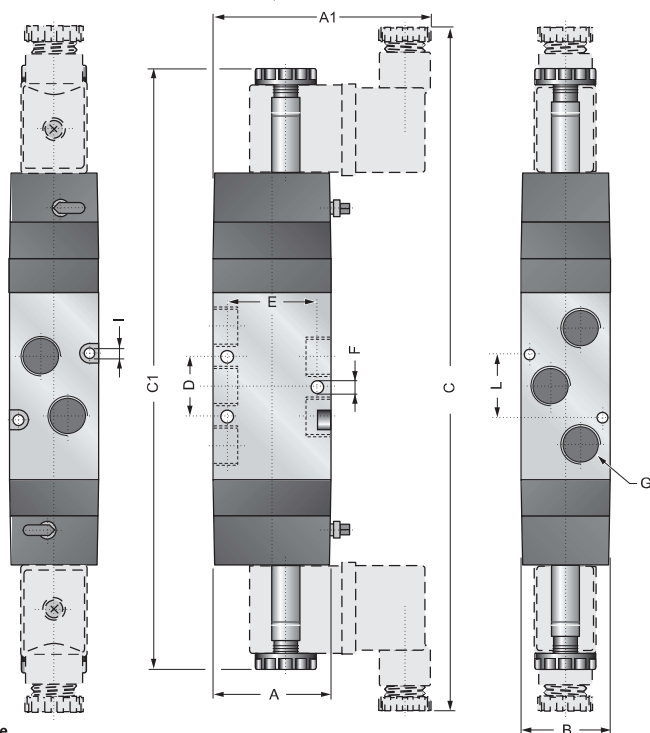

DIAGRAMS / DIAGRAMMI

SIMBOLS / SIMBOLI

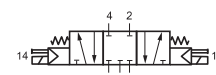
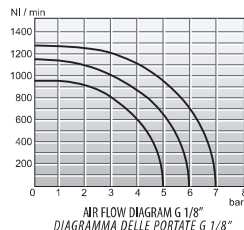

E53W2S61 -

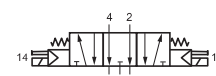

E53W2S91 -

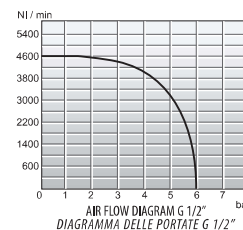
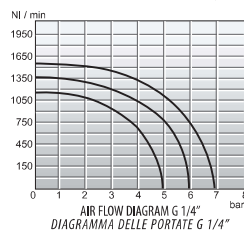

Size Taglia	A	A1	B	C	C1	D	E	ØF	G	ØI	L
1/8	30	63	26	227	198	18	23	4,25	G1/8	3,25	28,6
1/4	40	73	30	232	203	20	30	4,25	G1/4	3,25	21
1/2	60	60	40	280	252	40	50	5,5	G1/2	—	—

(*) ATEX versions see P. B-113
Versioni ATEX vedi P. B-113



ME .18

DOUBLE INLET MANIFOLD FOR ASSEMBLING VALVES AND SOLENOID VALVES G1/8
 BASE A DOPPIO INGRESSO PER ASSEMBLAGGIO VALVOLE ED ELETTROVALVOLE G1/8

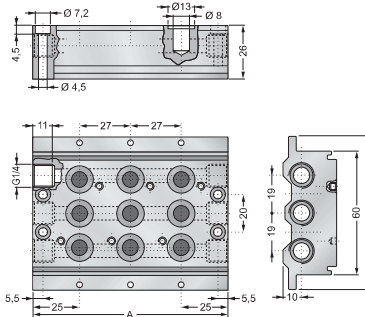
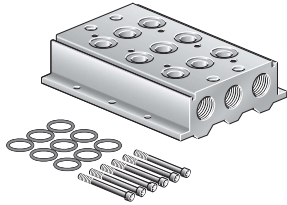

- Gaskets and screws for assembling valves on manifold are included.
- Nella confezione sono presenti le guarnizioni e le viti per fissare le valvole alla base.

CODES / CODICI

Code Codice	A A	Place Posti
ME 218	77	2
ME 318	104	3
ME 418	131	4
ME 518	158	5
ME 618	185	6
ME 718	212	7
ME 818	239	8
ME 918	266	9
ME 1018	293	10

ME .14

DOUBLE INLET MANIFOLD FOR ASSEMBLING VALVES AND SOLENOID VALVES G1/4
 (* BASE A DOPPIO INGRESSO PER ASSEMBLAGGIO VALVOLE ED ELETTROVALVOLE G1/4

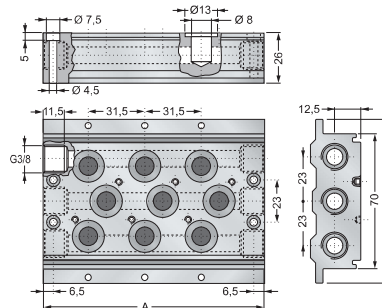
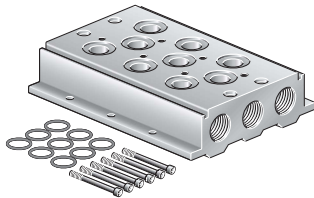

- Gaskets and screws for assembling valves on manifold are included.
- Nella confezione sono presenti le guarnizioni e le viti per fissare le valvole alla base.

CODES / CODICI

Code Codice	A A	Place Posti
ME 214	91,5	2
ME 314	123	3
ME 414	154,5	4
ME 514	186	5
ME 614	217,5	6
ME 714	249	7
ME 814	280,5	8
ME 914	312	9
ME 1014	343,5	10

(* ATEX versions see / Versioni ATEX vedi P. B-116

SEALS KIT AND ACCESSORIES FOR VALVES AND SOLENOID VALVES G 1/8 AND G 1/4 RICAMBI ED ACCESSORI PER VALVOLE ED ELETTROVALVOLE G 1/8 E G 1/4

KM 018 (G1/8)

KM 014 (G1/4)

ASSEMBLING KIT
 KIT DI ASSEMBLAGGIO

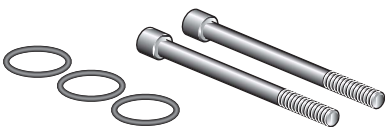

- Subbases are supplied with assembling screws and seals.
- Kit of screws and seals can be supplied also as spare parts with the code **KM 018** and **KM 014**.
- Le basi sono complete delle viti e delle guarnizioni necessarie per il fissaggio delle valvole. Tuttavia può essere fornito come ricambio il kit **KM 018** per il fissaggio di singole valvole da G1/8 oppure **KM 014** per il fissaggio di singole valvole da G1/4

PCH 018 (G1/8)

PCH 014 (G1/4)

PLUG-FLAT
 CHIUSURA POSTO INUTILIZZATO

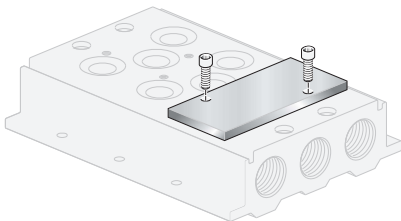

PCH 018

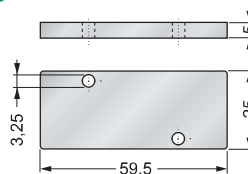

PCH 014

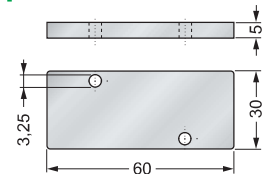

SET .1/4 e 1/2 SG

SEALS KIT
 KIT GUARNIZIONI DI RICAMBIO

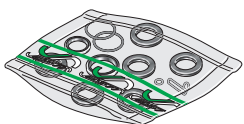

Seals kit code - Codice del kit

- SET 1 1/4 SG:** for G1/4 **mono-stable** valves - per valvole **monostabili** G1/4.
- SET 2 1/4 SG:** for G1/4 **bi-stable** valves - per valvole **bistabili** G1/4
- SET 1 1/2 SG:** for G1/2 **mono-stable** valves - per valvole **monostabili** G1/2.
- SET 2 1/2 SG:** for G1/2 **bi-stable** valves - per valvole **bistabili** G1/2.

Example / Esempio: E52W1SM14-02400 → SET 1 1/4 SG

E52W2S014-02400 → SET 2 1/4 SG

EXAMPLE OF MODULAR ASSEMBLING OF VALVES AND SOLENOID VALVES G1/8
ESEMPIO DI ASSEMBLAGGIO MODULARE DI VALVOLE ED ELETTROVALVOLE G1/8

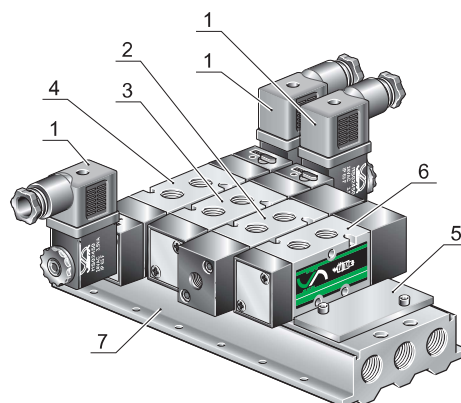
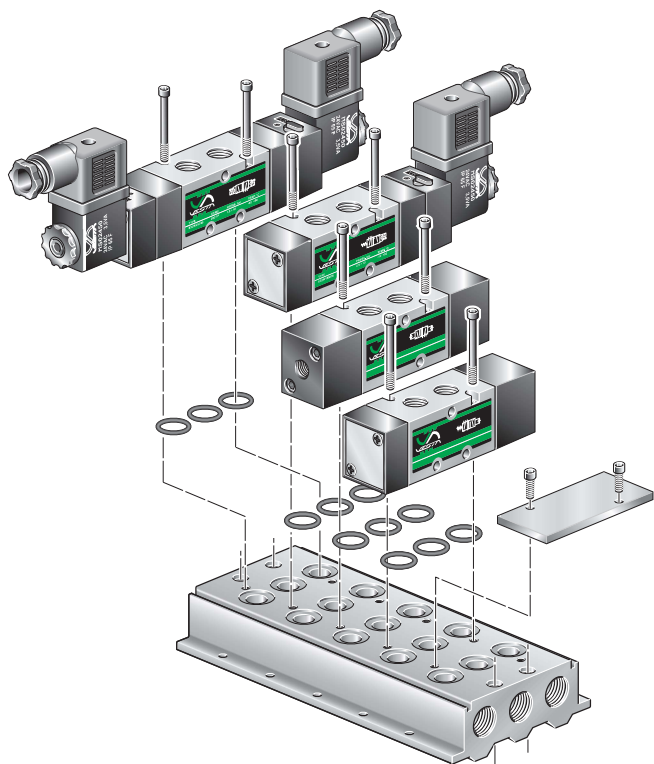

Components needed for assembling the manifold on the picture.
 Esempio di componenti necessari a realizzare la batteria raffigurata.

Position Posizione	Quantity Quantità	Code Codice
1	N° 3	CEP/1
2	N° 1	V52V2P018
3	N° 1	E52W1S018 - 02450
4	N° 1	E52W2S018 - 02450
5	N° 1	PCH 018
6	N° 1	V52V1PM18
7	N° 1	ME 518

EXAMPLE OF MODULAR ASSEMBLING OF VALVES AND SOLENOID VALVES G1/4
ESEMPIO DI ASSEMBLAGGIO MODULARE DI VALVOLE ED ELETTROVALVOLE G1/4

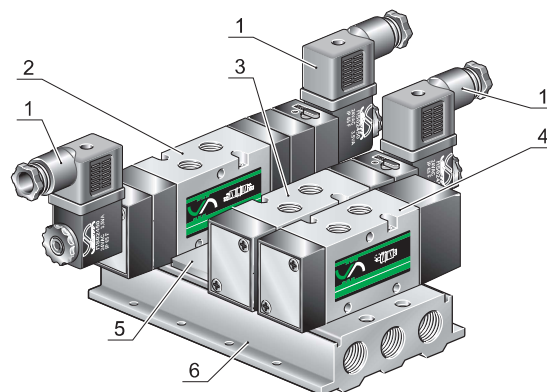
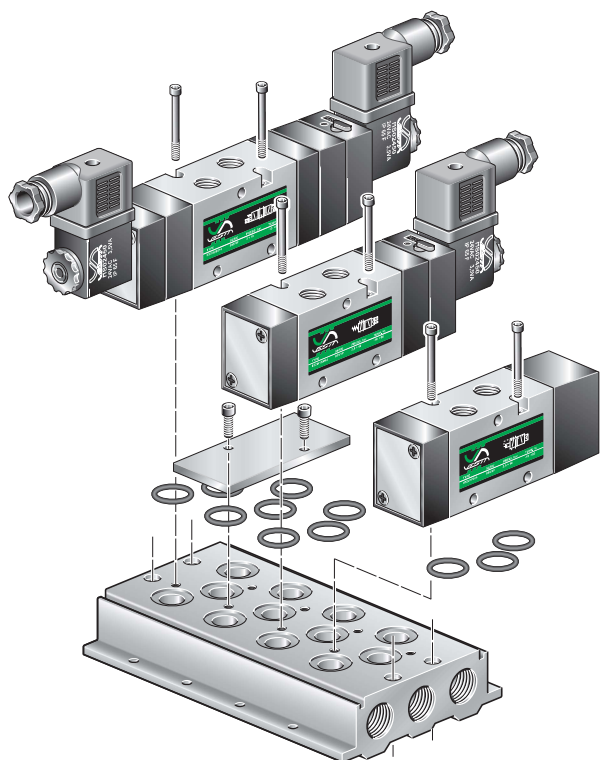

Components needed for assembling the manifold on the picture.
 Esempio di componenti necessari a realizzare la batteria raffigurata.

Position Posizione	Quantity Quantità	Code Codice
1	N° 3	CEP/1
2	N° 1	E53W2S914 - 02450
3	N° 1	E52W1SM14 - 02450
4	N° 1	V52V1PM14
5	N° 1	PCH014
6	N° 1	ME 414



COLLECTOR FOR VALVES AND SOLENOID VALVES G1/8
ASSEMBLAGGIO SU COLLETTORE DELLE VALVOLE ED ELETTROVALVOLE G 1/8

RTCOV . 18

SBCOV . 18

SACOV . 18

MANIFOLDS WITH COMMON INLET AIR FOR G1/8 VALVES
 COLLETTORI PER VALVOLE FILETTATE G1/8

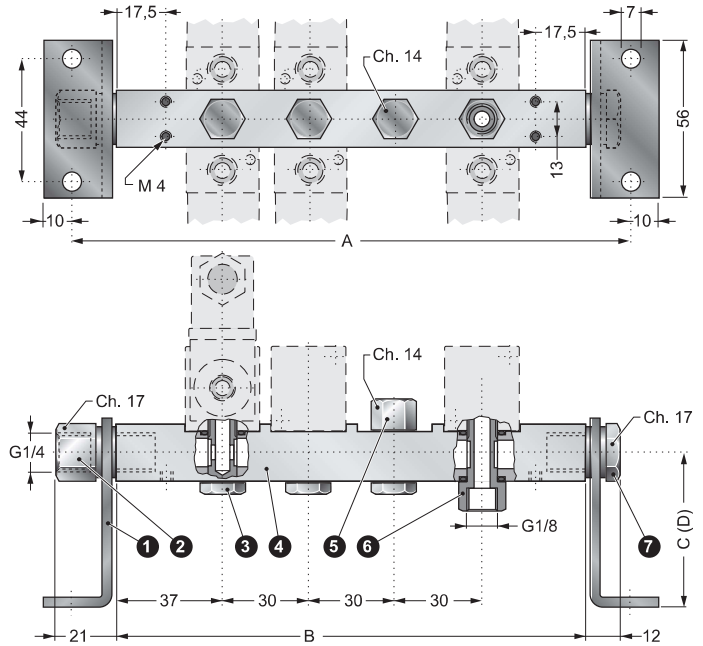
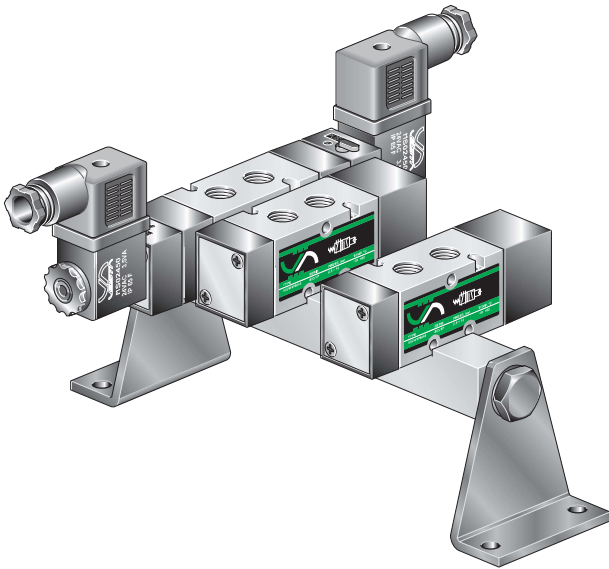

CODES / CODICI

Code
Codice

A B C D Place
Posti

ASSEMBLED MANIFOLD RT018 WITH FITTINGS
COLLETTORE RT018 COMPLETO DI RACCORDI

RTCOV218	-	104	-	-	2
RTCOV318	-	134	-	-	3
RTCOV418	-	164	-	-	4
RTCOV518	-	194	-	-	5

ASSEMBLED MANIFOLD RT018 WITH FITTINGS AND LOW SUPPORTS SB018
COLLETTORE RT018 COMPLETO DI RACCORDI E SUPPORTI BASSI SB018

SBCOV218	134	104	72	-	2
SBCOV318	164	134	72	-	3
SBCOV418	194	164	72	-	4
SBCOV518	224	194	72	-	5

ASSEMBLED MANIFOLD RT018 WITH FITTINGS AND HIGH SUPPORTS SA018
COLLETTORE RT018 COMPLETO DI RACCORDI E SUPPORTI ALTI SA018

SACOV218	134	104	-	125	2
SACOV318	164	134	-	125	3
SACOV418	194	164	-	125	4
SACOV518	224	194	-	125	5

Position Posizione	Code Codice	Description Descrizione
1	SB018 (ref. C) SA018 (ref. D)	Low supports mounted "C" / <i>Supporto basso "C"</i> High supports mounted "D" / <i>Supporto alto "D"</i>
2	RFS18	Fixing supports fitting with air inlet <i>Raccordo fissaggio supporto con connessione</i>
3	RT018	Fixing valve fitting <i>Raccordo fissaggio valvola</i>
4	COV218 COV318 COV418 COV518	Manifold 2 valves / <i>Collettore 2 valvole</i> Manifold 3 valves / <i>Collettore 3 valvole</i> Manifold 4 valves / <i>Collettore 4 valvole</i> Manifold 5 valves / <i>Collettore 5 valvole</i>
5	TF018	Closed fitting <i>Tappo chiusura raccordo</i>
6	RTP18	Fixing valve fitting with air inlet <i>Raccordo di fissaggio valvola passante</i>
7	RC018	Fixing supports fitting <i>Raccordo di chiusura collettore</i>

The maximum allowed numbers of valves you can use on a single collector depends on the air consumption of the valves, number of valves actuated at the same time and the air consumption downstream. Fittings and supports are supplied with washers

Il numero massimo di valvole dipende dal consumo totale d'aria, da quante valvole vengono azionate contemporaneamente e dalla portata degli utilizzi collegati a valle. I raccordi di fissaggio valvole e supporti vengono forniti completi di rondelle di tenuta.

COLLECTOR FOR VALVES AND SOLENOID VALVES G1/4
ASSEMBLAGGIO SU COLLETTORE DELLE VALVOLE ED ELETTROVALVOLE G 1/4

RTCOV . 14
SBCOV . 14
SACOV . 14

MANIFOLDS WITH COMMON INLET AIR FOR G1/4 VALVES
 COLLETTORI PER VALVOLE FILETTATE G1/4

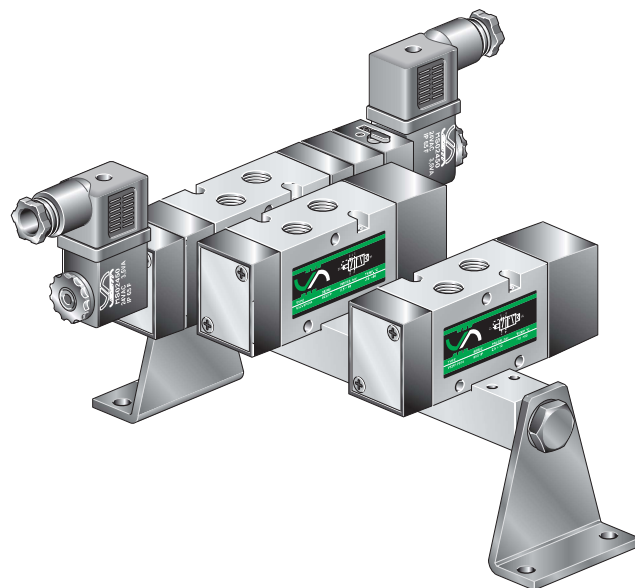
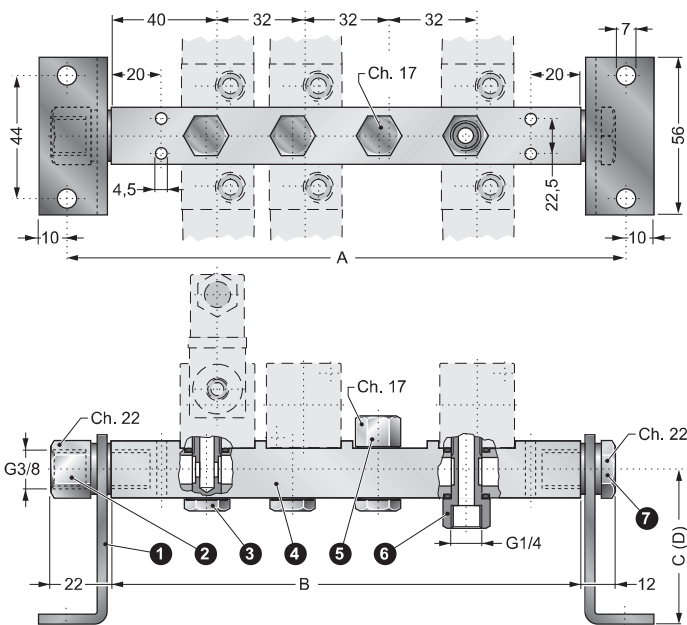

CODES / CODICI

Position Posizione	Code Codice	Description Descrizione
1	SB014 (ref. C) SA014 (ref. D)	Low supports mounted "C" / <i>Supporto basso "C"</i> High supports mounted "D" / <i>Supporto alto "D"</i>
2	RFS14	Fixing supports fitting with air inlet <i>Raccordo fissaggio supporto con connessione</i>
3	RT014	Fixing valve fitting <i>Raccordo fissaggio valvola</i>
4	COV214 COV314 COV414 COV514	Manifold 2 valves / <i>Collettore 2 valvole</i> Manifold 3 valves / <i>Collettore 3 valvole</i> Manifold 4 valves / <i>Collettore 4 valvole</i> Manifold 5 valves / <i>Collettore 5 valvole</i>
5	TF014	Closed fitting <i>Tappo chiusura raccordo</i>
6	RTP14	Fixing valve fitting with air inlet <i>Raccordo di fissaggio valvola passante</i>
7	RC014	Fixing supports fitting <i>Raccordo di chiusura collettore</i>

Code Codice	A	B	C	D	Place Posti
----------------	---	---	---	---	----------------

ASSEMBLED MANIFOLD **RT014** WITH FITTINGS
 COLLETTORE **RT014** COMPLETO DI RACCORDI

RTCOV214	-	112	-	-	2
RTCOV314	-	144	-	-	3
RTCOV414	-	176	-	-	4
RTCOV514	-	208	-	-	5

ASSEMBLED MANIFOLD **RT014** WITH FITTINGS AND LOW SUPPORTS **SB014**
 COLLETTORE **RT014** COMPLETO DI RACCORDI E SUPPORTI BASSI **SB014**

SBCOV214	134	104	95	-	2
SBCOV314	164	134	95	-	3
SBCOV414	194	164	95	-	4
SBCOV514	224	194	95	-	5

ASSEMBLED MANIFOLD **RT014** WITH FITTINGS AND HIGH SUPPORTS **SA014**
 COLLETTORE **RT014** COMPLETO DI RACCORDI E SUPPORTI ALTI **SA014**

SACOV214	134	104	-	133	2
SACOV314	164	134	-	133	3
SACOV414	194	164	-	133	4
SACOV514	224	194	-	133	5

The maximum allowed numbers of valves you can use on a single collector depends on the air consumption of the valves, number of valves actuated at the same time and the air consumption downstream.
 Fittings and supports are supplied with washers

Il numero massimo di valvole dipende dal consumo totale d'aria, da quante valvole vengono azionate contemporaneamente e dalla portata degli utilizzatori collegati a valle. I raccordi di fissaggio valvole e supporti vengono forniti completi di rondelle di tenuta.